

HTU31V RH/T SENSOR IC

Analog Relative Humidity sensor with Temperature output

Characteristics

- Fully calibrated, temperature compensated
- Voltage supply range from 3V to 5.5V
- Typical accuracy $\pm 2\%RH$ and $\pm 0.2^{\circ}C$
- Fast response time
- Compact 6-Pin DFN package
- Ratio metric voltage output
- Qualified according to AEC Q100 grade 1 standard
- Typical power consumption down to 15 μ W

Key Features

- High reliability and environmental robustness
- Full interchangeability with no calibration required in standard conditions
- Quick recovery after long periods in saturation phase
- Compatible with automatic assembly processes
- Reflow solderable
- Individual marking for compliance to stringent traceability requirements
- Lead free sensor
- Low power consumption

Applications

- Home Appliance
- Medical
- Printers
- Humidifier
- Automotive
- Meteorology
- Environmental Monitoring

General description

Today's demands for energy efficient sensors in appliance, consumer, industrial, and medical applications require optimal system performance to meet environmental and end user expectations.

The HTU31 is one of the smallest and most accurate humidity sensors on the market. Our precision engineering and 20+ years of experience in humidity and temperature combination sensors, enables us to provide fast response time, precision measurement, low hysteresis and sustained performance even when exposed to extreme temperature (-40° to $125^{\circ}C$) and humidity environments (0%-100%).

The HTU31 humidity sensor includes both digital (D) and analog (V) versions, and combines multiple functions and various interfaces (I2C, analog, voltage output) with an application-friendly operating voltage range (3.3-5.5V with 5V typical). The HTU31 humidity and temperature sensor is available in small and large volumes to meet the ever-changing demands of our customers.

PERFORMANCE SPECIFICATION

Performance Specifications (Humidity)

@25°C, Vdd=5V

Characteristics	Condition	Value	Units	Notes / Conditions
Humidity Operating Range	Max ¹	0 to 100	%RH	
Relative Humidity Accuracy	Typical	±2	%RH	Figure 1 Humidity sensor rating @25°C
Hysteresis	@25°C	±0.7	%RH	
Response Time ²	$\tau_{63\%}$	5	s	
Recovery time after 150 hours of condensation	Typical	10	s	
Long term drift ³	Typical	0.5	%RH/yr	

Table 1 Humidity sensor specification

Performance Specifications (Temperature)

Characteristics	Condition	Value	Units	Notes / Conditions
Temperature Operating Range		-40 to 125	°C	
Temperature Accuracy	Typical	±0.2	°C	Figure 2 Temperature sensor rating
Response Time ²	$\tau_{63\%}$	10	s	
Long term drift ³	Typical	0.04	°C/yr	

Table 2 Temperature sensor specification¹ See Figure 3 Humidity and Temperature operating range² Under 1 m.s-1 air flow³ Typical application mean that see regular environmental variation within optimum measurement range.

Humidity sensor rating

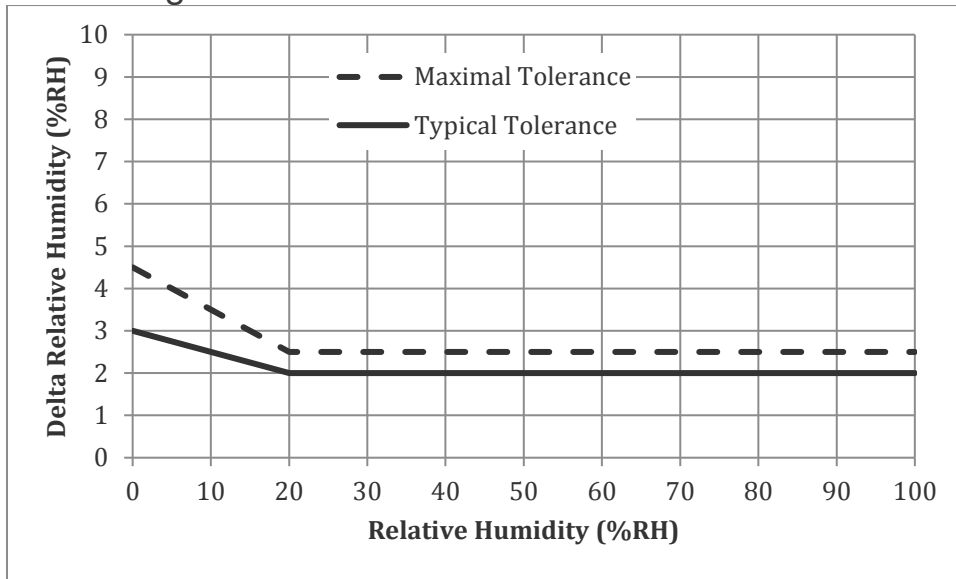

Figure 1 Humidity sensor rating @25°C

Temperature sensor rating

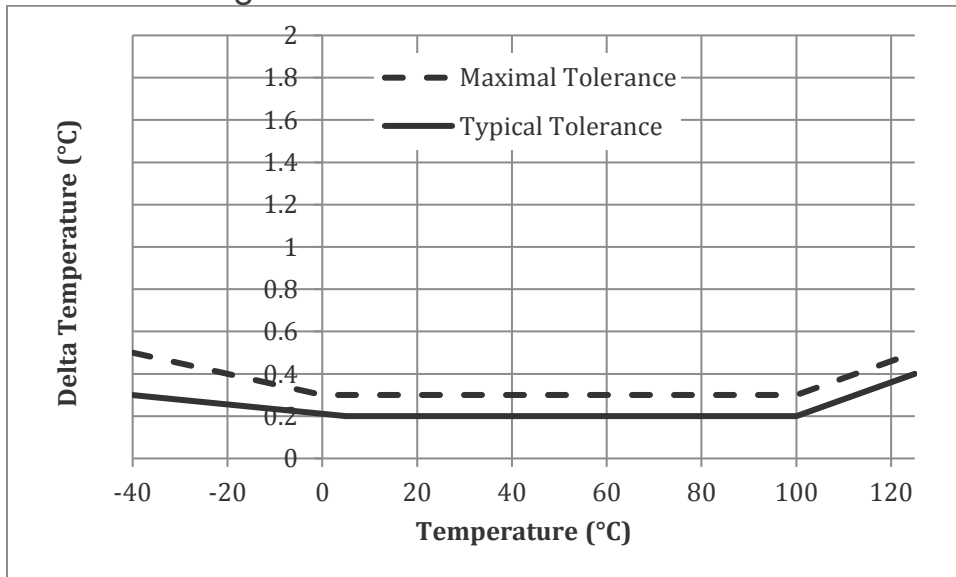

Figure 2 Temperature sensor rating

SENSOR INTEGRATION

Absolute Maximum rating

Ratings	Symbol	Value	Unit	Notes / Conditions
Storage Temperature ⁴	Tstg	-40 to 150	°C	
Supply Voltage (Peak)	Vcc	6V	Vdc	
Humidity Operating Range	RH	0 to 100	%RH	
Temperature Operating Range	Ta	-40 to +125	°C	
VDD to GND		-0.3 to 6V	V	
ESD HBM (human body model) ⁵		±4	kV	
ESD Charged device model ⁶		750	V	
ESD Machine model ⁷		±200	V	

Table 3 Maximum Rating

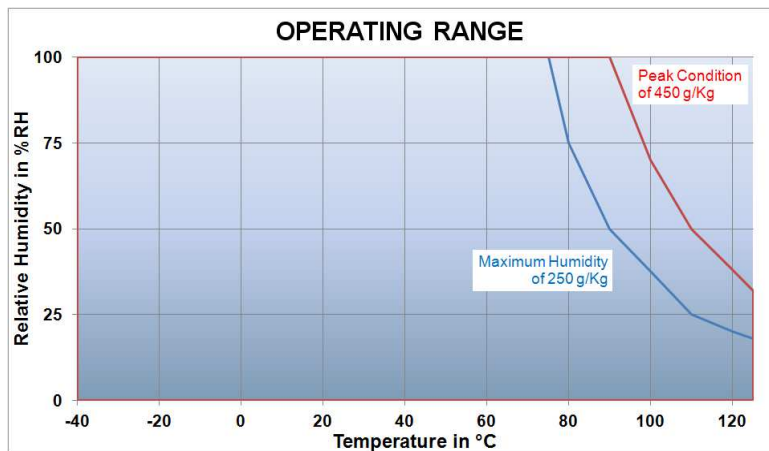

Figure 3 Humidity and Temperature operating range

The sensor should operate at peak condition less than 10% of the operating life. Exposure to absolute maximum rating conditions for extended periods may temporarily offset RH measurement (+5%RH above accuracy specification, that slowly will recover over time) and accelerate its ageing.

⁴ Sensor in specification after 1000h storage @150°C

⁵ According to ANSI/ESDA/JEDEC JS-001-2014; AEC-Q100-002.

⁶ ESDA ESD-STM5.3.1-1999 and AEC-Q100-011 (charged device model, 750V corner pins, 500V other pins)

⁷ JEDEC JESD22-A115 method (Machine Model ±200V)

HTU31V RH/T SENSOR IC

Analog Relative Humidity sensor with Temperature output

Electrical specification

$V_{dd} = 5V @25^{\circ}C$

Characteristics	Symbol	Min	Typ	Max	Unit	Notes / Conditions
Voltage Supply	V_{dd}	3.0	5.0	5.5	V	
Current consumption	i_{dd}		2.9		μA	Average
				450	μA	Peak
Power Dissipation			15		μW	Average

Table 4 Electrical specification

Timing specification for sensor

Characteristics	Symbol	Min	Typ	Max	Unit	Notes / Conditions
Power up time				10	ms	

Table 5 Timing specification@25°C Vdd = 5V

INTERFACES

PIN assignment

N°	Function	Comment
1	RH Output	Volts, Output
2	GND	Ground
3	TBC	To be Connected*
4	RST	Reset Pin**
5	VDD	Supply Voltage
6	T	Temperature, Output

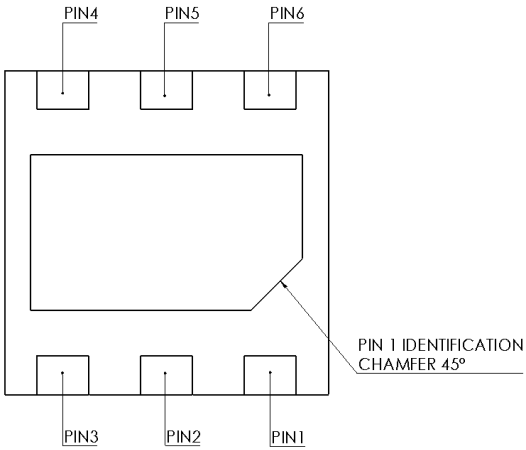

Table 6 Pin Assignment

Power Pins (VDD; GND)

Typical application circuit includes a 100nF decoupling capacitor between VDD and GND, placed as close as possible to the sensor.

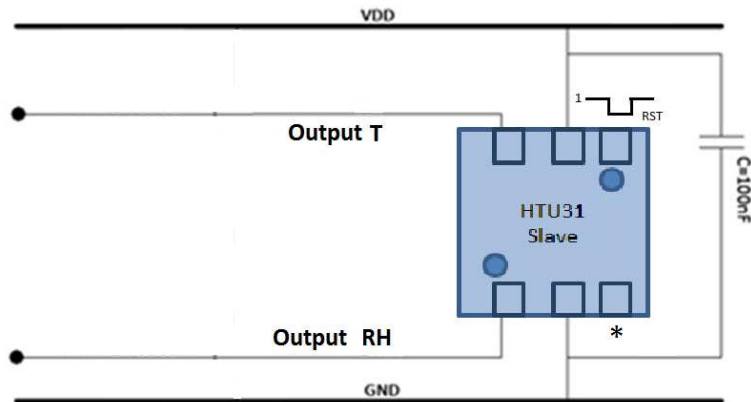

Figure 4 Typical application circuit, including pull-up resistor R_p and decoupling of VDD and GND by a capacitor

COMMUNICATION AND OPERATION

Relative humidity output reading

@V_{dd}= 5V

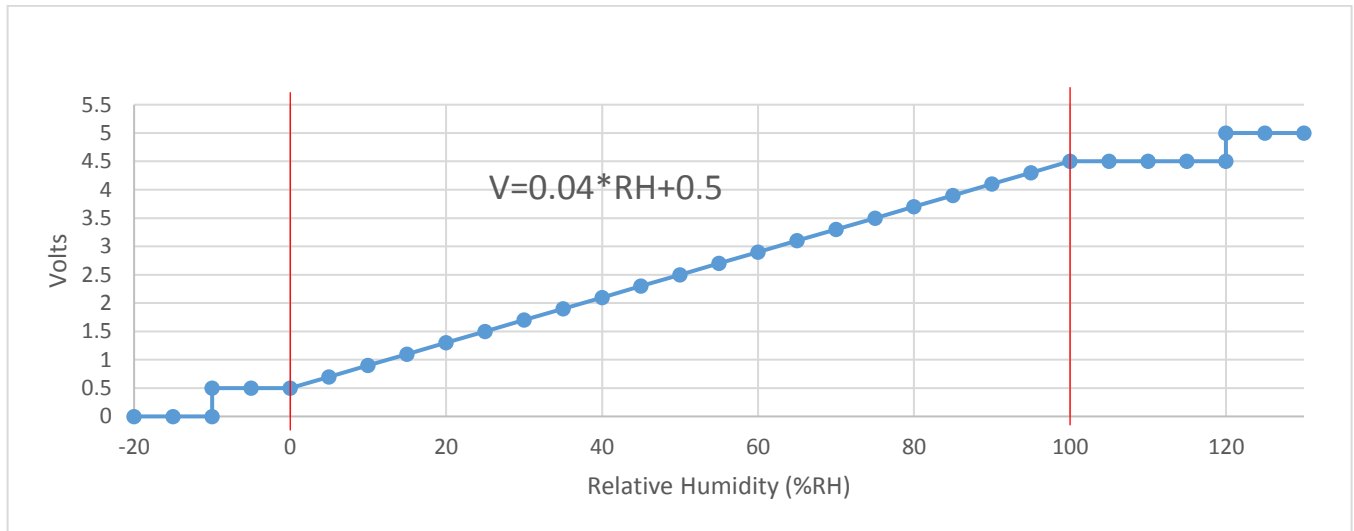

Figure 5 RH look-up table

$$V_{RH} = 0,1V_{dd} + \frac{0,8V_{dd}}{100} RH\%$$

Equation 1 Generic RH Conversion

Temperature output reading

@V_{dd}= 5V

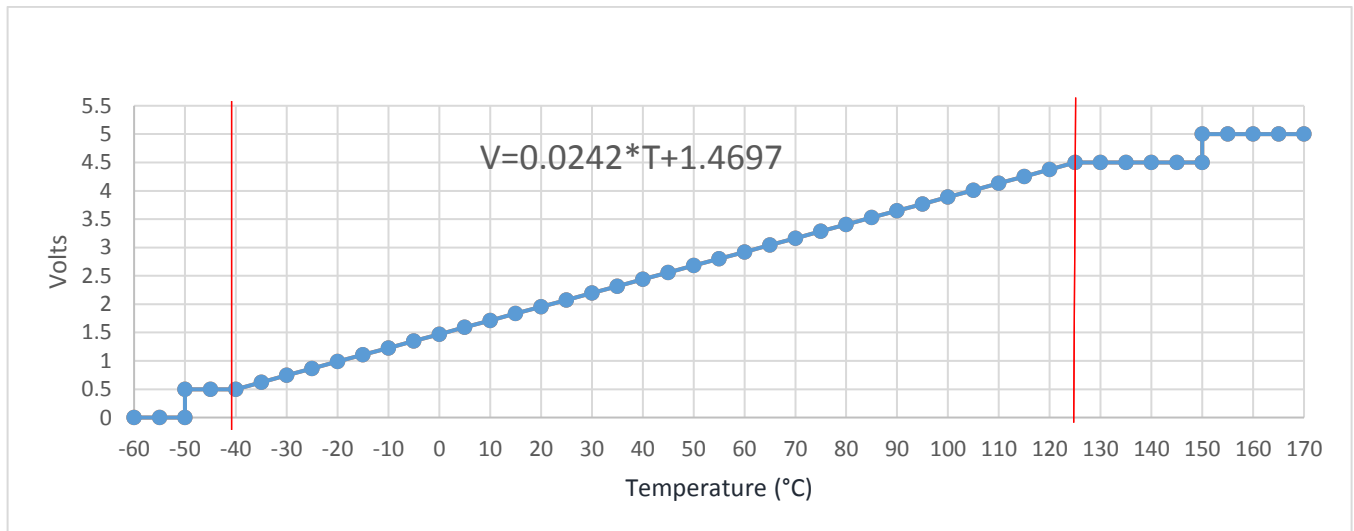

$$V_T = 0,1V_{dd} + \frac{0,8V_{dd}}{165} (40 + T^{\circ}C)$$

Equation 2 Generic Temperature conversion

HTU31V RH/T SENSOR IC

Analog Relative Humidity sensor with Temperature output

PACKAGING INFORMATION

Package outline

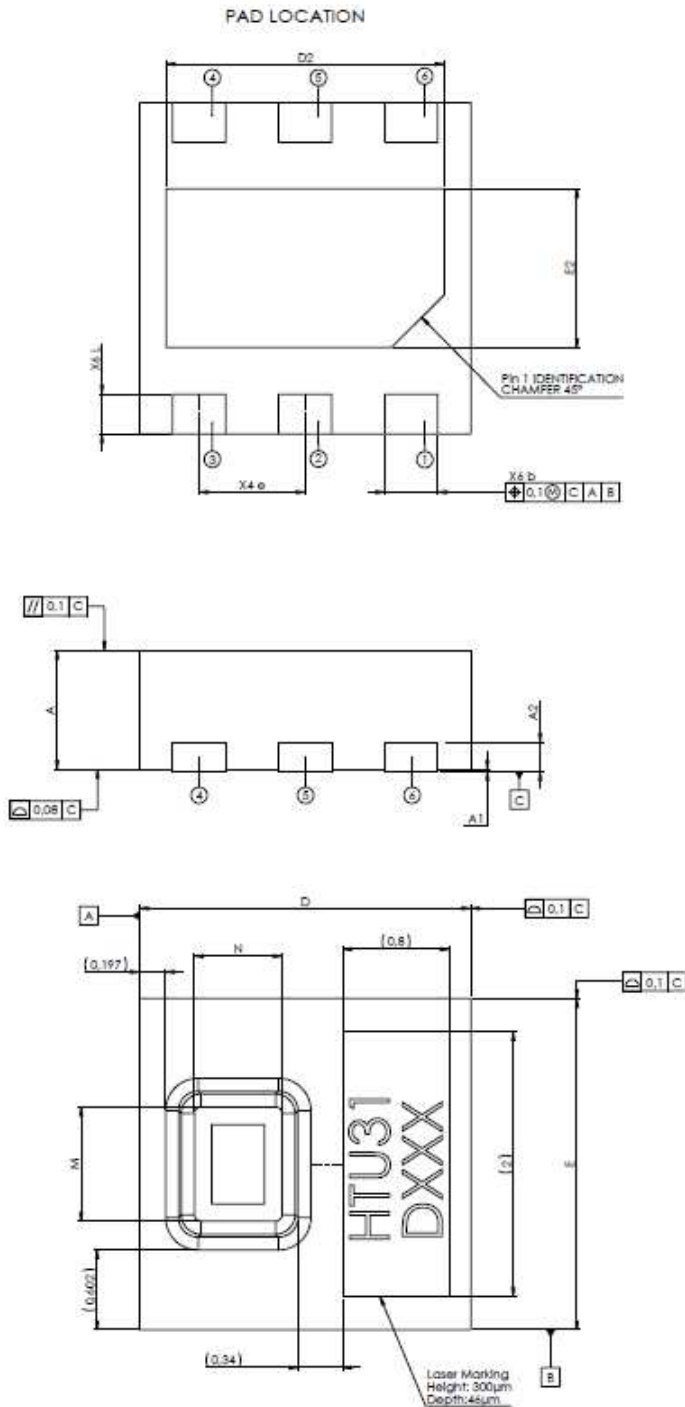

SYMBOL	COMMON					
	DIMENSIONS MILLIMETER			DIMENSIONS INCH		
	MIN.	NOM.	MAX.	MIN.	NOM.	MAX.
A	0.85	0.90	0.95	0.033	0.035	0.037
A1	0.00	0.02	0.05	0.000	0.001	0.002
A2	0.203 REF			0.008 REF		
b	0.35	0.40	0.45	0.014	0.016	0.018
D	2.45	2.50	2.55	0.096	0.098	0.100
D2	2.05	2.10	2.15	0.081	0.083	0.085
E	2.45	2.50	2.55	0.096	0.098	0.100
E2	1.15	1.20	1.25	0.045	0.047	0.049
e	0.80 BSC			0.031 BSC		
L	0.25	0.30	0.35	0.010	0.012	0.014
M	0.860 REF			0.034 REF		
N	0.660 REF			0.026 REF		

HTU31V RH/T SENSOR IC

Analog Relative Humidity sensor with Temperature output

Packaging Type

HTU31D sensors are provided in DFN type package. DFN stands for Dual Flat No leads.

The HTU31D sensor chip is mounted to a lead frame made of Cu and plated with Ni/Pd/Au.

Traceability Information

All HTU31D sensors are laser marked with an alphanumeric, six-digit code on the sensor as pictured below.

The marking on the HTU31D sensor consists of two lines with five digits each:

- The first line denotes the sensor type: HTU31.
- The second line denotes various information including:
 - The first digit of the second line defines the output mode:
 - D = Digital and I²C
 - V = Analog
 - The second and third digits define the manufacturing year: 19=2019, 20=2020 .
 - The last three digits represent an alphanumeric tracking code. That code represents the day of the year.

Reels are also labeled, as displayed below and give additional traceability information.



With:

- 3X: Sensor Type (31 for HTU31)
- Y: Output mode (V = Analog)
- TTTTTTTTT: MEAS Traceability Code
- QQQQ: Quantity per reel (400, 1500 or 5000 units)
- YY: Last two digits of the year
- DDD: Day of the year

HTU31V RH/T SENSOR IC

Analog Relative Humidity sensor with Temperature output

Tape and Reel Packaging

HTU31D sensors are shipped in tape & reel packaging, sealed into antistatic ESD bags.

Standard packaging sizes are 400, 1500 and 5000 units per reel. Each reel contains 440mm (55 pockets) header tape and 200mm (25 pockets) trailer tape. The drawing of the packaging tapes with sensor orientation is shown in the picture below.

For 400 and 1500 units: outside diameter of 7" (178mm) and a 1/2" (13mm) diameter arbor hole.

For 5000 units: outside diameter of 13" (330mm) and a 1/2" (13mm) diameter arbor hole.

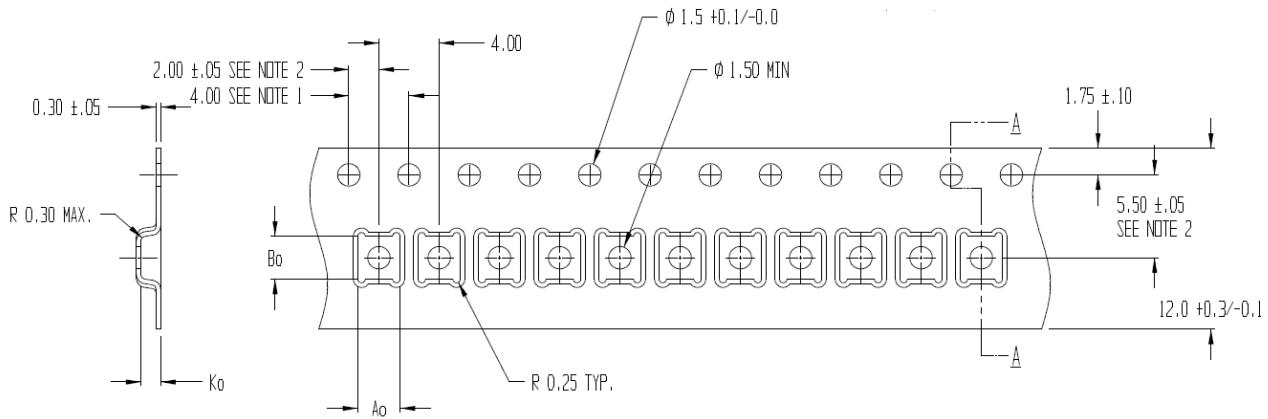

Table 7 Technical drawing of tape and reel

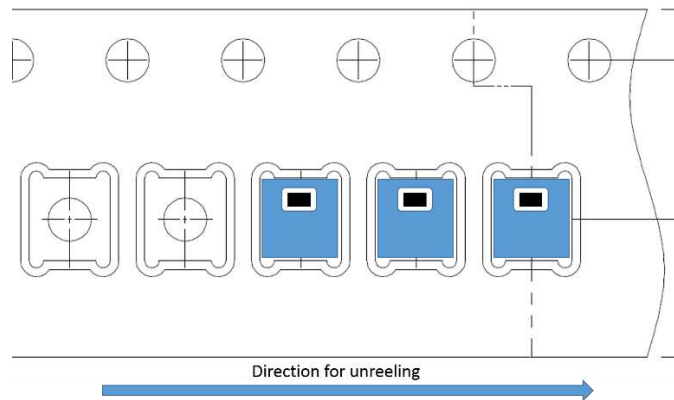

Figure 6 Product orientation in tape and reel packaging

Recommended footprint for PCBa assembly

All dimensions are in mm

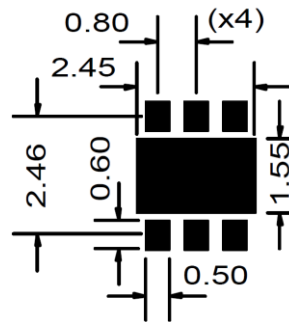

Figure 7 Recommended footprint

HTU31V RH/T SENSOR IC

Analog Relative Humidity sensor with Temperature output

Handling / Storage recommendations

In order to use and preserve the high quality performance of the HTU31 humidity and temperature sensor, the following recommendations have to be followed concerning storage and packaging.

Please read the paragraph below carefully and note that all precautions are applicable for design phases, production phases as well as in case of returned material to Measurement Specialties.

When sensors are not used or assembled, we recommend storing them in their original sealed anti ESD packaging. If sensors have been removed from their original packaging, we recommend keeping them into anti-static shielded ESD bags.

Such SMD sensors is classified MSL level 1 according to IPC/JEDEC J-STD-020.1 for storage, packaging and handling.

We recommend a shelf life of 1 year in following conditions of temperature and relative humidity $\leq 30^{\circ}\text{C}$ 85%RH.



Protection against ESD mandatory

HTU31V RH/T SENSOR IC

Analog Relative Humidity sensor with Temperature output

QUALITY

Qualification of HTU31 is performed based on AEC Q 100 grade 1 standard.

MATERIAL CONTENT

The device is fully RoHS and REACH compliant.

ORDERING INFORMATION

HTU31X

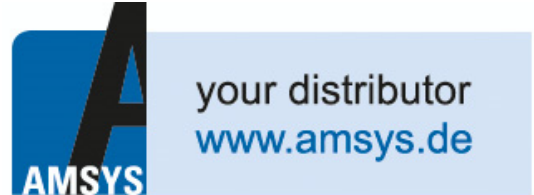

Output Signal	
Code	Output Type
D	I ² C Digital
V	Radiometric voltage

Description	Quantity	Part number
HTU31D I.C 31D RH/T DIGITAL R400	400	10142048-00
HTU31D I.C 31D RH/T DIGITAL R1500	1500	10142048-01
HTU31D I.C 31D RH/T DIGITAL R5000	5000	10142048-02
HTU31V I.C 31V RH/T ANALOG R400	400	10142048-10
HTU31V I.C 31V RH/T ANALOG R1500	1500	10142048-11
HTU31V I.C 31V RH/T ANALOG R5000	5000	10142048-12

REVISION HISTORY

DATE	VERSION	PAGE(S)	CHANGES
November 2019	1		-

NORTH AMERICA

Tel +1 800 522 6752
customercare.hmpt@te.com

EUROPE

Tel +31 73 624 6999
customercare.tlse@te.com

ASIA

Tel +86 0400 820 6015
customercare.shzn@te.com

te.com/sensorsolutions

MEAS, TE Connectivity, TE, and the TE connectivity (logo) are trademarks owned or licensed by the TE Connectivity Ltd. family of companies. Other logos, products and/or company names referred to herein may be trademarks of their respective owners.

The information given herein, including drawings, illustrations and schematics which are intended for illustration purposes only, is believed to be reliable. However, TE Connectivity makes no warranties as to its accuracy or completeness and disclaims any liability in connection with its use. TE Connectivity's obligations shall only be as set forth in TE Connectivity's Standard Terms and Conditions of Sale for this product and in no case will TE Connectivity be liable for any incidental, indirect or consequential damages arising out of the sale, resale, use or misuse of the product. Users of TE Connectivity products should make their own evaluation to determine the suitability of each such product for the specific application.

© 2019 TE Connectivity All Rights Reserved.