

H(T)U(F)3500 SERIES

Analog Relative Humidity module with Temperature output

SPECIFICATIONS

- Compact plug and play module with no external component required
- Can operate under 5VDC or 3VDC
- Relative Humidity and Temperature Analog Output
- Full interchangeability. No calibration required
- Can operate under 5VDC or 3VDC
- Low power consumption
- Fast response time

Based on the new humidity sensor HTU21P, HTU3500 Series are dedicated humidity and temperature plug and play transducer designed for OEM applications where reliable and accurate measurements are needed. Direct interface with a micro-controller is made possible with the modules humidity linear voltage and direct NTC outputs. The HTU3500 Series are designed for high volume and demanding applications where power consumption is critical.

Optional PTFE filter/membrane (F) protects HTU3500 Series modules analog humidity modules with temperature output against dust, water immersion as well as against contamination by particles. PTFE filter/membrane preserves a high response time. Several connectors are proposed. 5VDC or 3VDC power supply products are available.

HU3500 – analog Humidity sensor only – can be proposed

FEATURES

- Full interchangeability with no calibration required in standard conditions
- Instantaneous desaturation after long periods in saturation phase
- Analog output
- Demonstrated reliability and long term stability
- Reliability not affected by repeated condensation
- HU3500 – analog humidity sensor only – can be proposed

APPLICATIONS

- Home appliance
- Medical
- Printers
- Humidifier

H(T)U(F)3500 SERIES

Analog Relative Humidity module with Temperature output

NOMENCLATURE

H(T)U(F)3X3Yzzz

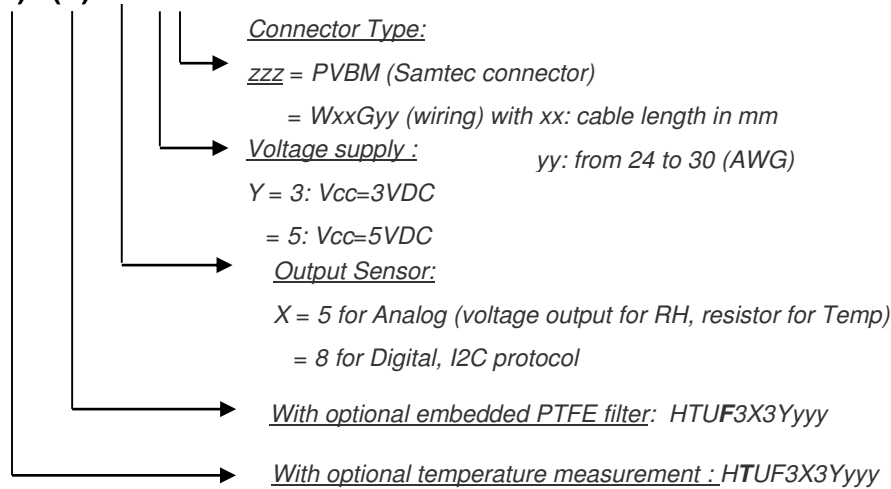

PERFORMANCE SPECS

MAXIMUM RATINGS

Ratings		Symbol	Value	Unit
Storage Temperature		T _{stg}	-40 to 125	°C
Supply Voltage (Peak)	HTU3533 products	V _{cc}	16V	V _{dc}
	HTU3535 products	V _{cc}	16V	V _{dc}
Humidity Operating Range		RH	0 to 100	%RH
Temperature Operating Range		T _a	-40 to +85	°C
VDD to GND	HTU3533 products		-0.3 to 3.6V	V
	HTU3535 products		-16 to 16V	V
Input current on any pin			-10 to +10	mA

Peak conditions: less than 10% of the operating time

Exposure to absolute maximum rating conditions for extended periods may affect the sensor reliability.

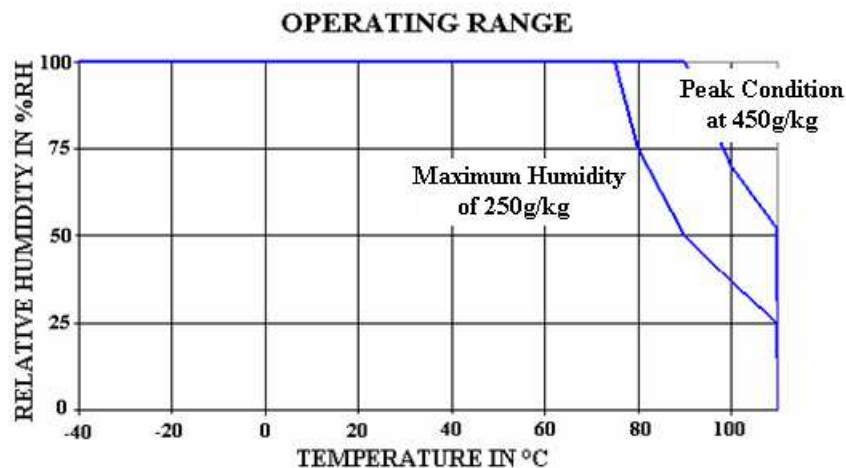

H(T)U(F)3500 SERIES

Analog Relative Humidity module with Temperature output

ELECTRICAL AND GENERAL ITEMS

• HTU35Y3

Characteristics	Symbol	Min	Typ	Max	Unit
Voltage Supply ^{(1) (2)}	V _{cc}	2.85	3.0	3.15	V _{dc}
Nominal Output @55%RH	V _{out}		1.490		V
Humidity Average Sensitivity	ΔmV/RH	-	+16	-	mV/%RH
Current consumption	I _{cc}	-	1.0	1.2	mA dc

(1) Module is ratiometric to voltage supply

(2) Maximum power supply ramp up time to VCC should be less than 20ms

HTU35Y5

Characteristics	Symbol	Min	Typ	Max	Unit
Voltage Supply ^{(1) (2)}	V _{cc}	4.75	5	5.25	V _{dc}
Nominal Output @55%RH	V _{out}	2.401	2.480	2.559	V
Humidity Average Sensitivity	ΔmV/RH	-	+26	-	mV/%RH
Current consumption	I _{cc}	-	1.2	1.5	mA dc

(1) Module is ratiometric to voltage supply

Maximum power supply ramp up time to VCC should be less than 20ms

SENSOR PERFORMANCE

ELECTRICAL CHARACTERISTICS

(@T=23°C, R_L>1MΩ unless otherwise noted)

Humidity Characteristics	Symbol	Min	Typ	Max	Unit
Humidity Measuring Range	RH	0		100	%RH
Relative Humidity Accuracy (20% to 80%RH)			±2	See graph	%RH
Temperature coefficient (10°C to 50°C)	T _{cc}			-0.15	%RH/°C
Recovery time after 150 hours of condensation	t		10		s
Humidity hysteresis			+/-1		%RH
Output impedance	Z			50	Ω
Sink current capability (R _{L_Min} = 8 kOhms) ⁽¹⁾	I			1	mA
Warm up time (90% of signal)	t _w		150		ms
Time Constant (at 63% of signal) 33%RH to 75%RH ⁽²⁾	τ		5	10	s

(1) Conditions of sink current: V_{out} + 0.054V (3%RH) at V_{out} = 0.600 V (V_{out} min)

(2) At 1m/s air flow

Temperature Characteristics*	Symbol	Min	Typ	Max	Unit
Nominal resistance @ 25°C	R	9.9	10	10.1	kΩ
Beta value : B25/50	B	3346	3380	3414	K
Temperature measuring range	T _a	-40		+80	°C
Nominal Resistance Tolerance at 25°C	R _n		1		%
B value tolerance	B		1		%
Time Constant	τ		10		s

* Except for low temperatures

H(T)U(F)3500 SERIES

Analog Relative Humidity module with Temperature output

POWER SUPPLY OPTION OF HTU3500 SERIES AT 3V_{DC} OR AT 5V_{DC}

At 3V_{DC} or at 5V_{DC} power supply, there is no measurable impact of type of powering on temperature and RH accuracy.

HUMIDITY LOOK-UP TABLES

HTU3535 Modeled Voltage Output				HTU3533 Modeled Voltage Output			
Reference Output Values (V _{CC} = 5V)				Reference Output Values (V _{CC} = 3V)			
0	V _{out} (mV)	RH (%)	V _{out} (mV)	RH (%)	V _{out} (mV)	RH (%)	V _{out} (mV)
10	1235	55	2480	10	740	55	1490
15	1390	60	2605	15	835	60	1565
20	1540	65	2730	20	925	65	1640
25	1685	70	2860	25	1010	70	1715
30	1825	75	2990	30	1095	75	1795
35	1960	80	3125	35	1175	80	1875
40	2090	85	3260	40	1255	85	1955
45	2220	90	3400	45	1330	90	2040
50	2350	95	3530	50	1410	95	2120

POLYNOMIAL EQUATIONS

$$V_{out} = 8.43E^{-4} RH^3 - 0.1485 RH^2 + 34.16 RH + 909$$

$$RH = -1.564E^{-9} V_{out}^3 + 1.205E^{-5} V_{out}^2 + 8.22E^{-3} V_{out} - 15.6$$

with V_{out} in mV and RH in %

LINEAR EQUATIONS

$$V_{out} = 26.23 RH + 1032$$

$$RH = 0.03812 V_{out} - 39.36$$

with V_{out} in mV and RH in %

POLYNOMIAL EQUATIONS

$$V_{out} = 5.05E^{-4} RH^3 - 8.91 E^{-2} RH^2 + 2.05 E^1 RH + 5.45 E^2$$

$$RH = -7,23 E^{-9} V_{out}^3 + 3,34 E^{-5} V_{out}^2 + 1,37 E^{-2} V_{out} - 15.6$$

with V_{out} in mV and RH in %

LINEAR EQUATIONS

$$V_{out} = 15.94 RH + 606$$

$$RH = 0,0627 V_{out} - 37,969$$

with V_{out} in mV and RH in %

RELATIVE HUMIDITY ERROR BUDGET CONDITIONS AT 25°C

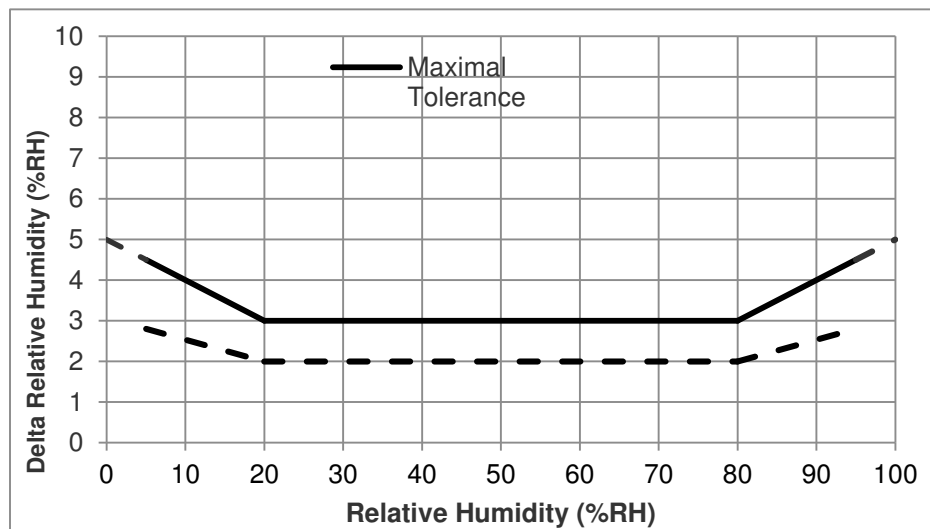

TEMPERATURE COEFFICIENT COMPENSATION EQUATION

For other temperatures than 25°C, the following temperature coefficient compensation equation can be used and will guarantee Relative Humidity accuracy given in table1, from 0°C to 80°C:

$$RH_{\text{compensated}T} = RH_{\text{actual}T} + f(T)$$

RH_{actual}T Ambient humidity in %RH, computed from HTU21D(F) sensor
 T_{actual} Humidity cell temperature in °C, computed from HTU21D(F) sensor
 f(T) RH correction (in %RH) is a linear function of the temperature T (°C) as described below:
 $f(T) = -0.15 * (25 - T)$

TEMPERATURE

Temperature Characteristics	Symbol	Min	Typ	Max	Unit
Nominal resistance @ 25°C	R	9.9	10	10.1	kΩ
Beta value : B25/50	B	3346	3380	3414	K
Temperature measuring range	T _a	-40		110	°C
Nominal Resistance Tolerance at 25°C	R _n		1		%
B value tolerance	B		1		%
Time Constant	τ		10		s

TYPICAL TEMPERATURE OUTPUT

Depending on the needed temperature measurement range and associated accuracy, we suggest two methods to access to the NTC resistance values.

$$R_T = R_N \times e^{\beta \left(\frac{1}{T} - \frac{1}{T_N} \right)}$$

R_T NTC resistance in Ω at temperature T in K
 R_N NTC resistance in Ω at rated temperature T in K
 T, T_N Temperature in K
 β Beta value, material specific constant of NTC
 e Base of natural logarithm (e=2.71828)

① The exponential relation only roughly describes the actual characteristic of an NTC thermistor can, however, as the material parameter β in reality also depend on temperature. So this approach is suitable for describing a restricted range around the rated temperature or resistance with sufficient accuracy.

② For practical applications, a more precise description of the real R/T curve may be required. Either more complicated approaches (e.g. the Steinhart-Hart equation) are used or the resistance/temperature relation as given in tabulation form. The below table has been experimentally determined with utmost accuracy for temperature increments of 1 degree.

Actual values may also be influenced by inherent self-heating properties of NTCs. Please refer to MEAS-France Application Note HPC106 “Low power NTC measurement

H(T)U(F)3500 SERIES

Analog Relative Humidity module with Temperature output

TEMPERATURE LOOK-UP TABLE

Temp (°C)	R (Ω)	Temp (°C)	R (Ω)	Temp (°C)	R (Ω)	Temp (°C)	R (Ω)
-40	195652	0	27219	40	5834	80	1669
-39	184917	1	26076	41	5636	81	1622
-38	174845	2	24988	42	5445	82	1578
-37	165391	3	23951	43	5262	83	1535
-36	156513	4	22963	44	5086	84	1493
-35	148171	5	22021	45	4917	85	1452
-34	140330	6	21123	46	4754	86	1413
-33	132958	7	20267	47	4597	87	1375
-32	126022	8	19450	48	4446	88	1338
-31	119494	9	18670	49	4301	89	1303
-30	113347	10	17926	50	4161	90	1268
-29	107565	11	17214	51	4026	91	1234
-28	102116	12	16534	52	3896	92	1202
-27	96978	13	15886	53	3771	93	1170
-26	92132	14	15266	54	3651	94	1139
-25	87559	15	14674	55	3535	95	1110
-24	83242	16	14108	56	3423	96	1081
-23	79166	17	13566	57	3315	97	1053
-22	75316	18	13049	58	3211	98	1026
-21	71677	19	12554	59	3111	99	999
-20	68237	20	12081	60	3014	100	974
-19	64991	21	11628	61	2922	101	949
-18	61919	22	11195	62	2834	102	925
-17	59011	23	10780	63	2748	103	902
-16	56258	24	10382	64	2666	104	880
-15	53650	25	10000	65	2586	105	858
-14	51178	26	9634	66	2509	106	837
-13	48835	27	9284	67	2435	107	816
-12	46613	28	8947	68	2364	108	796
-11	44506	29	8624	69	2294	109	777
-10	42506	30	8315	70	2228	110	758
-9	40600	31	8018	71	2163		
-8	38791	32	7734	72	2100		
-7	37073	33	7461	73	2040		
-6	35442	34	7199	74	1981		
-5	33892	35	6948	75	1925		
-4	32420	36	6707	76	1870		
-3	31020	37	6475	77	1817		
-2	29689	38	6253	78	1766		
-1	28423	39	6039	79	1716		

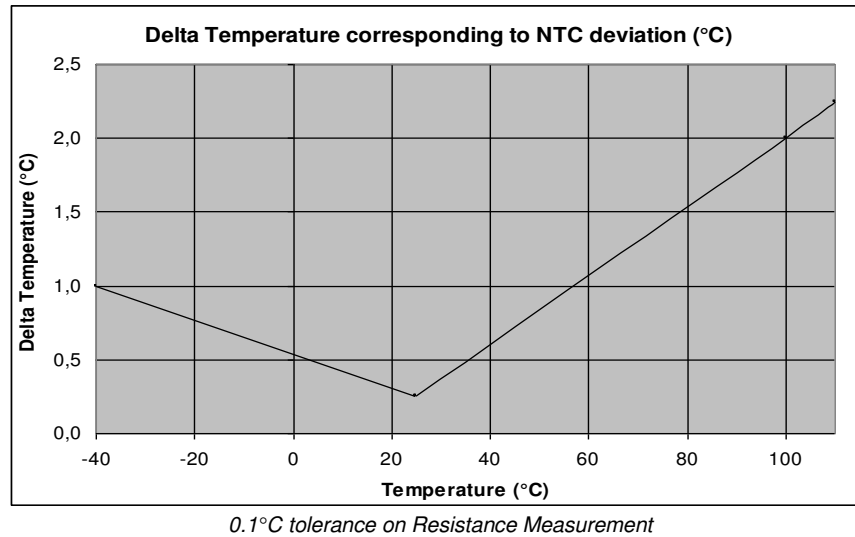
TEMPERATURE ERROR BUDGET**STEINHART-HART COEFFICIENTS**

According to the equation below, the Steinhart-Hart coefficients for the operating temperature range for HTU3500 products thermistor are:

$$\frac{1}{T} = a + b * \ln(R) + C * \ln(R) * \ln(R) * \ln(R)$$

- R NTC resistance in Ω at temperature T in K
- T Temperature in K
- a Constant value (a= 8.61393E-04)
- b Constant value (b= 2.56377E-04)
- c Constant value (c= 1.68055E-07)

TEMPERATURE INTERFACE CIRCUIT

Concerning the temperature sensor of the HTU3500 Series products, the following measuring method described below is based on a voltage bridge divider circuit. It uses only one resistor component (Rbatch) at 1% to design HTU3500 temperature sensor interfacing circuit.

Rbatch is chosen to be equal to NTC @25°C to get: $V_{out} = V_{cc}/2$ @25°C.

The proposal method connects Rbatch to Vcc and NTC to Ground. It leads to a negative slope characteristic (Pull-Up Configuration).

H(T)U(F)3500 SERIES

Analog Relative Humidity module with Temperature output

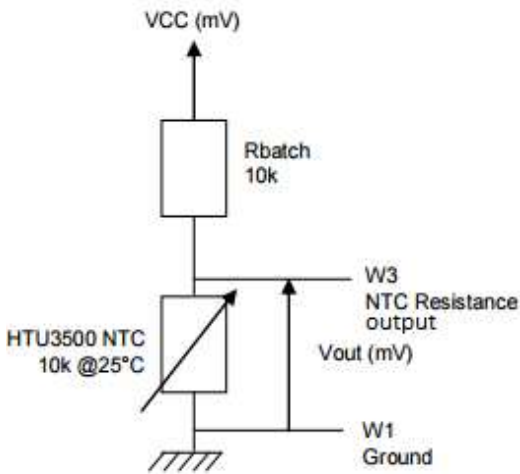

$$V_{OUT}(mV) = \frac{V_{CC}(mV) * NTC_{HTU3500}(\Omega)}{R_{batch}(\Omega) + NTC_{HTU3500}(\Omega)}$$

Temperature (°C)	Resistance (Ω)	For HTU3533 products (VCC=3VDC)	For HTU3535 products (VCC=5VDC)
		Pull-Up Configuration Vout (mV)	Pull-Up Configuration Vout (mV)
-40	195652	2854	4757
-30	113347	2757	4595
-20	68237	2617	4361
-10	42506	2429	4048
0	27219	2194	3657
10	17926	1926	3210
20	12081	1641	2736
25	10000	1500	2500
30	8315	1362	2270
40	5834	1105	1842
50	4161	882	1469
60	3014	695	1158
70	2228	547	911
80	1669	429	665
85	1452	380	634

- **Storage Conditions and Handling Instructions**

It is recommended to store HTU3500 Series sensor in its original packaging at following conditions: Temperature shall be in the range of -40°C – 125°C

APPLICATION: DEW POINT TEMPERATURE MEASUREMENT

The **dew point** is the temperature at which the water vapor in the air becomes saturated and condensation begins.

The dew point is associated with relative humidity. A high relative humidity indicates that the dew point is closer to the current air temperature. Relative humidity of 100% indicates that the dew point is equal to the current temperature (and the air is maximally saturated with water). When the dew point stays constant and temperature increases, relative humidity will decrease.

Dew point temperature of the air is calculated using Ambient Relative Humidity and Temperature measurements from HTU3500 Series sensor with following formulas given below

Partial Pressure (PP_{Tamb}) formula from Ambient Temperature:

$$PP_{Tamb} = 10^{\left[A - \frac{B}{(Tamb+C)} \right]}$$

H(T)U(F)3500 SERIES

Analog Relative Humidity module with Temperature output

Dew point Temperature (T_d) formula from Partial Pressure ($PP_{T_{amb}}$):

$$T_d = - \left[\frac{B}{\log_{10} \left(RH_{amb} \times \frac{PP_{T_{amb}}}{100} \right) - A} + C \right]$$

$PP_{T_{amb}}$	Partial Pressure in mmHg at ambient temperature (T_{amb})
RH_{amb}	Ambient humidity in %RH, computed from HTU3500 Series sensor
T_{amb}	Humidity cell temperature in °C, computed from HTU3500 Series sensor
T_d	Calculated Dew Point in °C
A, B, C	Constants: A=8.1332; B=1762.39; C=235.66

CONNECTING AND MECHANICAL CHARACTERISTICS

CONNECTING CHARACTERISTICS

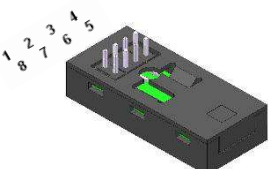
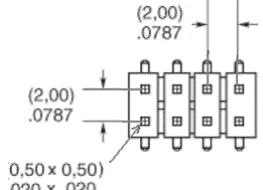
Connector Type*	Symbol	Overview	Connector Pitch	Mating Connector
Medium Male Connector ^{(1) (2)} (1.91 mm – 0.075 in long)	PVBM			Direct Soldering (through hole)

* For alternate connector type, please contact factory.

⁽¹⁾ For board-to-board mounting, we suggest wave soldering.

⁽²⁾ Pins are connected by twos.

Pin Out Assignment

N°	Function
1/8	Ground
2/7	Vcc – Voltage Supply
3/6	Tout – Temperature
4/5	RHout – Relative Humidity

WIRING CHARACTERISTICS

Connector Type	Symbol	Overview	More information*	Remote Mating Connector*
N/A	WxxGyy		Wxx: Wiring cable length* in mm Gyy: Wiring cable type* (from AWG 24 to 30):	N/A

* On request, please contact factory.

H(T)U(F)3500 SERIES

Analog Relative Humidity module with Temperature output

Pin Out Assignment (with wires)

N°	Colour	Function
1	Black	Ground
2	Red	Vcc – Voltage Supply
3	Brown	Tout – Temperature
4	Yellow	RHout – Relative Humidity

RESISTANCE TO PHYSICAL AND CHEMICAL STRESSES

HTU3500 series modules have been tested according to table below:

Environment	Standard	Results
Salt atmosphere	JESD22-A107-A	Within specification
Temperature cycling	-20°C / +85°C, 168 hours	Within specification
Thermal shocks	-20°C / +85°C, 500 cycles	Within specification
High temperature / Humidity operating life	93%RH / +60°C, 168 hours	Within specification
Resistance to immersion into water	Ambient temperature	Within specification
Low temperature storage	-20°C, 500 hours	Within specification
High temperature storage	+85°C, 500 hours	Within specification
ESD immunity	JEDEC JESD22-A114 JEDEC JESD22-A115	Within specification* Within specification**

* JEDEC JESD22-A114 method for connections & open window (Human Body Model at ± 8 kV powered and unpowered)

**JEDEC JESD22-A115 method (Machine Model ± 200 V)

HTU3500 Series are protected against reverse polarity.

HTU3500 Series are not light sensitive

ENVIRONMENTAL AND RECYCLING

HTU3500 series modules are lead free components and are compatible with Pb Free soldering process.

HTU3500 series modules are free from Cr (6+), Cd and Hg.

H(T)U(F)3500 SERIES

Analog Relative Humidity module with Temperature output

PACKAGE OUTLINE

MECHANICAL CHARACTERISTICS: HTU3500 SERIES PACKAGE OUTLINE

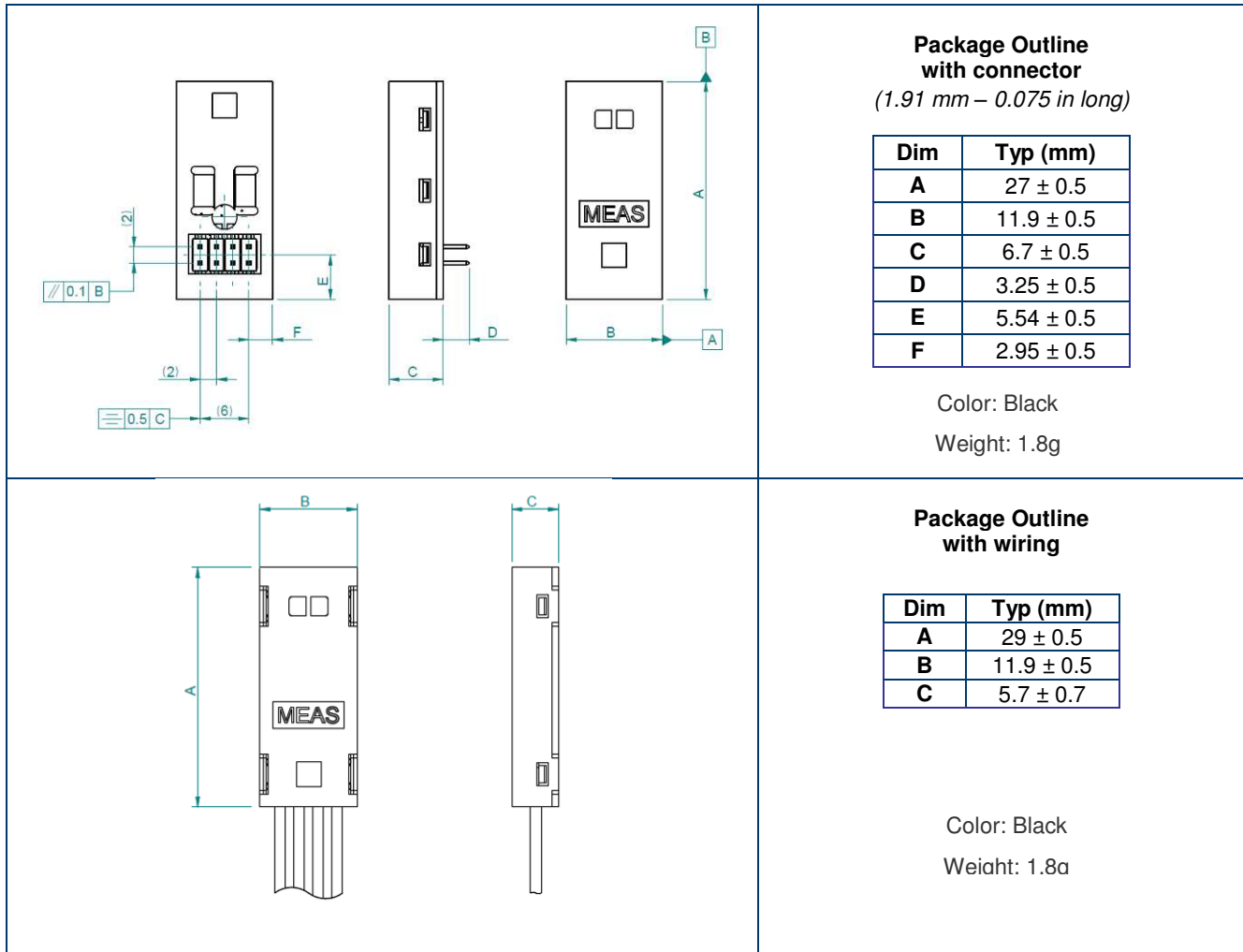

Double coated adhesive tape could be used on plastic housing area (ref: 3M – 5925F) to fix parts

H(T)U(F)3500 SERIES

Analog Relative Humidity module with Temperature output

ORDERING INFORMATION

Product	Order Reference	Status
HTU3515WXGY	HPP831NXXX	In design
HTU3535WXGY	HPP831CXXX	Engineering part
HTU3535PBVM	HPP831A610	Serial part
HTU3535CH	HPP831AXXX	In design

Samples are available through MEASUREMENT SPECIALTIES web site:

<http://www.meas-spec.com/humidity-sensors.aspx>



your distributor
AMSYS GmbH & Co.KG
An der Fahrt 4, 55124 Mainz, Germany
Tel. +49 (0) 6131 469 875 0
info@amsys.de | www.amsys.de

EUROPE

Measurement Specialties, Inc - MEAS France
Impasse Jeanne Benozzi
CS 83 163
31027 Toulouse Cedex 3
FRANCE
Tél: +33 (0)5 820 822 02
Fax: +33(0)5 820 821 51
Sales: humidity.sales@meas-spec.com

TE.com/sensorsolutions

Measurement Specialties, Inc., a TE Connectivity company.

Measurement Specialties, TE Connectivity, TE Connectivity (logo) and EVERY CONNECTION COUNTS are trademarks. All other logos, products and/or company names referred to herein might be trademarks of their respective owners.

The information given herein, including drawings, illustrations and schematics which are intended for illustration purposes only, is believed to be reliable. However, TE Connectivity makes no warranties as to its accuracy or completeness and disclaims any liability in connection with its use. TE Connectivity's obligations shall only be as set forth in TE Connectivity's Standard Terms and Conditions of Sale for this product and in no case will TE Connectivity be liable for any incidental, indirect or consequential damages arising out of the sale, resale, use or misuse of the product. Users of TE Connectivity products should make their own evaluation to determine the suitability of each such product for the specific application.

© 2015 TE Connectivity Ltd. family of companies All Rights Reserved.