



## MS5803-01BA

### Miniature Variometer Module

The MS5803-01BA is a new generation of high resolution altimeter sensors from TE Connectivity with SPI and I<sup>2</sup>C bus interface. The MS5803-01BA HE is the high endurance pad technology version of the MS5803-01BA pressure sensor module. It is optimized for altimeters and variometers with an altitude resolution of 10 cm. The sensor module includes a high linearity pressure sensor and an ultra-low power 24 bit  $\Delta\Sigma$  ADC with internal factory calibrated coefficients. It provides a precise digital 24 Bit pressure and temperature value and different operation modes that allow the user to optimize for conversion speed and current consumption. A high resolution temperature output allows the implementation of an altimeter/thermometer function without any additional sensor. The MS5803-01BA can be interfaced to virtually any microcontroller. The communication protocol is simple, without the need of programming internal registers in the device. The gel protection and antimagnetic stainless steel cap allows the use in 100m water resistant altimeter/compass watches. This new sensor module generation is based on leading MEMS technology and latest benefits from TE proven experience and know-how in high volume manufacturing of altimeter modules, which have been widely used for over a decade. The sensing principle employed leads to very low hysteresis and high stability of both pressure and temperature signal.

## FEATURES

- ◆ High resolution module, 10cm
- ◆ Fast conversion down to 1 ms
- ◆ Low power, 1  $\mu$ A (standby < 0.15  $\mu$ A)
- ◆ Integrated digital pressure sensor (24 bit  $\Delta\Sigma$  ADC)
- ◆ Supply voltage 1.8 to 3.6 V
- ◆ Operating range: 10 to 1300 mbar, -40 to +85 °C
- ◆ I<sup>2</sup>C and SPI interface (Mode 0, 3)
- ◆ No external components (Internal oscillator)
- ◆ Excellent long term stability
- ◆ Hermetically sealable for outdoor devices
- ◆ High Endurance (HE version)

## APPLICATIONS

- ◆ Mobile altimeter / barometer systems
- ◆ Bike computers
- ◆ Adventure or multi-mode watches
- ◆ Variometers
- ◆ Dataloggers
- ◆ High endurance pad technology (HE version)

Sensor Performances ( $V_{DD} = 3\text{ V}$ )				
Pressure	Min	Typ	Max	Unit
Range	10		1300	mbar
ADC	24			bit
Resolution (1)	0.065 / 0.042 / 0.027 / 0.018 / 0.012			mbar
Accuracy 25°C, 750 to 1100 mbar	-1.5		+1.5	mbar
Accuracy -20°C to +85°C, 300 to 1100 mbar (2)	-2.5		+2.5	mbar
Response time	0.5 / 1.1 / 2.1 / 4.1 / 8.22			ms
Long term stability		-1		mbar/yr
Temperature	Min	Typ	Max	Unit
Range	-40		+85	°C
Resolution		<0.01		°C
Accuracy	-0.8		+0.8	°C
Notes: (1) Oversampling Ratio: 256 / 512 / 1024 / 2048 / 4096				
(2) With autozero at one pressure point				

**FUNCTIONAL BLOCK DIAGRAM**

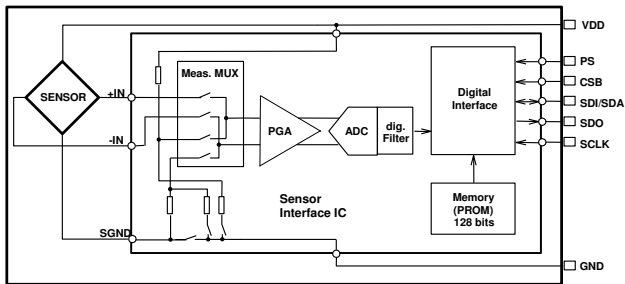

## PERFORMANCE SPECIFICATIONS

## ABSOLUTE MAXIMUM RATINGS

Parameter	Symbol	Conditions	Min.	Typ.	Max	Unit
Supply voltage	V <sub>DD</sub>		-0.3		+4.0	V
Storage temperature <sup>(3)</sup>	T <sub>S</sub>		-40		+125	°C
Overpressure	P <sub>max</sub>	ISO22810 <sup>(1)</sup>			10	bar
Maximum Soldering Temperature <sup>(2)</sup>	T <sub>max</sub>	40 sec max			250	°C
ESD rating		Human Body Model	-4		+4	kV
Latch up		JEDEC standard No 78	-100		+100	mA

<sup>(1)</sup> Qualified referring to ISO 22810, pressure ramp up/down min 60s

<sup>(2)</sup> Refer to application note 808

<sup>(3)</sup> Storage in an environment of dry and non-corrosive gases

## ELECTRICAL CHARACTERISTICS

Parameter	Symbol	Conditions	Min.	Typ.	Max	Unit
Operating Supply voltage	V <sub>DD</sub>		1.8	3.0	3.6	V
Operating Temperature	T		-40	+25	+85	°C
Supply current (1 sample per sec.)	I <sub>DD</sub>	OSR 4096 2048 1024 512 256		12.5 6.3 3.2 1.7 0.9		μA
Peak supply current		during conversion		1.4		mA
Standby supply current		at 25°C		0.02	0.14	μA
VDD Capacitor		From VDD to GND	100			nF

## ANALOG DIGITAL CONVERTER (ADC)

Parameter	Symbol	Conditions	Min.	Typ.	Max	Unit
Output Word				24		bit
Conversion time <sup>(4)</sup>	t <sub>c</sub>	OSR 4096 2048 1024 512 256	7.40 3.72 1.88 0.95 0.48	8.22 4.13 2.08 1.06 0.54	9.04 4.54 2.28 1.17 0.60	ms

<sup>(4)</sup> Maximum values must be used to determine waiting times in I2C communication

## PERFORMANCE SPECIFICATIONS (CONTINUED)

PRESSURE OUTPUT CHARACTERISTICS ( $V_{DD} = 3\text{ V}$ ,  $T = 25^\circ\text{C}$  UNLESS OTHERWISE NOTED)

Parameter	Conditions		Min.	Typ.	Max	Unit
Operating Pressure Range	$P_{\text{range}}$	Full Accuracy	300		1100	mbar
Extended Pressure Range	$P_{\text{ext}}$	Linear Range of ADC	10		1300	mbar
Absolute Accuracy, no autozero <sup>(1)</sup>	at $25^\circ\text{C}$ , 700..1100 mbar		-1.5		+1.5	mbar
	at $0..50^\circ\text{C}$ , 300..1100 mbar		-2.0		+2.0	
	at $-20..85^\circ\text{C}$ , 300..1100 mbar		-3.5		+3.5	
	at $-40..85^\circ\text{C}$ , 300..1100 mbar		-6.0		+6.0	
Absolute Accuracy, autozero at one pressure point <sup>(1)</sup>	at $25^\circ\text{C}$ , 700..1100 mbar		-0.5		+0.5	mbar
	at $0..50^\circ\text{C}$ , 300..1100 mbar		-1.0		+1.0	
	at $-20..85^\circ\text{C}$ , 300..1100 mbar		-2.5		+2.5	
	at $-40..85^\circ\text{C}$ , 300..1100 mbar		-5.0		+5.0	
Maximum error with supply voltage <sup>(3)</sup>	$V_{DD} = 1.8\text{ V} \dots 3.6\text{ V}$			+/- 2		mbar
Long-term stability <sup>(2)</sup>				-1		mbar/yr
Resolution RMS	OSR	4096		0.012		mbar
		2048		0.018		
		1024		0.027		
		512		0.042		
		256		0.065		

(1) Wet/dry cycle: sensor must be dried typically once a day.

(2) The long-term stability is measured with non-soldered devices.

(3) With autozero at 3V point

TEMPERATURE OUTPUT CHARACTERISTICS ( $V_{DD} = 3\text{ V}$ ,  $T = 25^\circ\text{C}$  UNLESS OTHERWISE NOTED)

Parameter	Conditions		Min.	Typ.	Max	Unit
Absolute Accuracy	at $25^\circ\text{C}$		-0.8		+0.8	$^\circ\text{C}$
	$-20..85^\circ\text{C}$		-2.0		+2.0	
	$-40..85^\circ\text{C}$		-4.0		+4.0	
Maximum error with supply voltage <sup>(4)</sup>	$V_{DD} = 1.8\text{ V} \dots 3.6\text{ V}$			+/- 0.5		$^\circ\text{C}$
Resolution RMS	OSR	4096		0.002		$^\circ\text{C}$
		2048		0.003		
		1024		0.005		
		512		0.008		
		256		0.012		

(4) With autozero at 3V point

## PERFORMANCE SPECIFICATIONS (CONTINUED)

## DIGITAL INPUTS (PS, CSB, DIN, SCLK, SDA, SCL)

Parameter	Symbol	Conditions	Min.	Typ.	Max	Unit
Serial data clock	SCLK	SPI protocol			20	MHz
Serial data clock	SCL	I2C protocol			400	kHz
Input high voltage	V <sub>IH</sub>	Pins CSB	80% V <sub>DD</sub>		100% V <sub>DD</sub>	V
Input low voltage	V <sub>IL</sub>		0% V <sub>DD</sub>		20% V <sub>DD</sub>	V
Input leakage current	I <sub>leak25°C</sub>	at 25°C			0.15	μA
CS low to first SCLK rising	t <sub>CSL</sub>		21			ns
CS low from last SCLK falling	t <sub>CSH</sub>		21			ns

## DIGITAL OUTPUTS (DOUT, SDA, SCL)

Parameter	Symbol	Conditions	Min.	Typ.	Max	Unit
Output high voltage	V <sub>OH</sub>	I <sub>source</sub> = 0.6 mA	80% V <sub>DD</sub>		100% V <sub>DD</sub>	V
Output low voltage	V <sub>OL</sub>	I <sub>sink</sub> = 0.6 mA	0% V <sub>DD</sub>		20% V <sub>DD</sub>	V
Load capacitance	C <sub>LOAD</sub>			16		pF

## PERFORMANCE CHARACTERISTICS

### PRESSURE ERROR VS PRESSURE AND TEMPERATURE

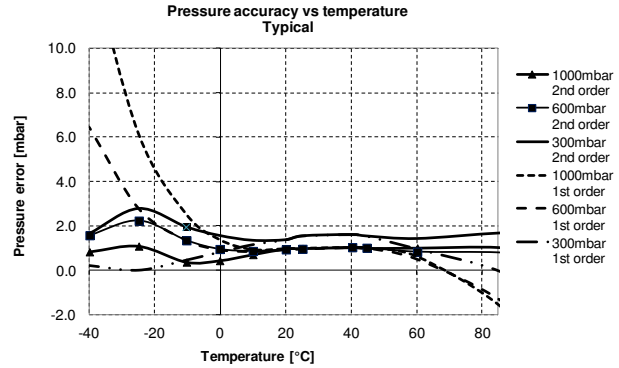
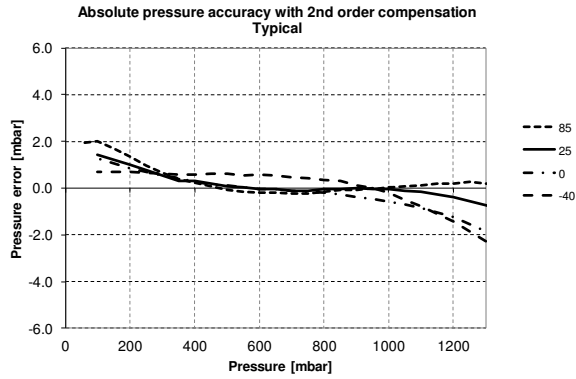

### TEMPERATURE ERROR VS TEMPERATURE

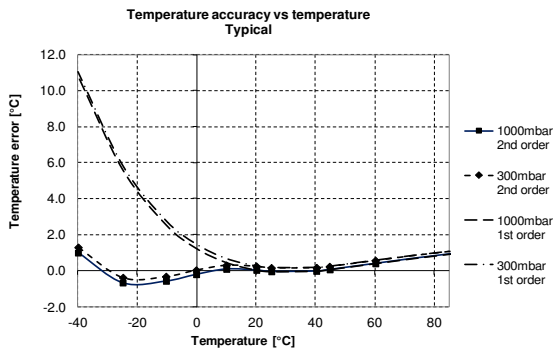

### PRESSURE AND TEMPERATURE ERROR VS SUPPLY VOLTAGE

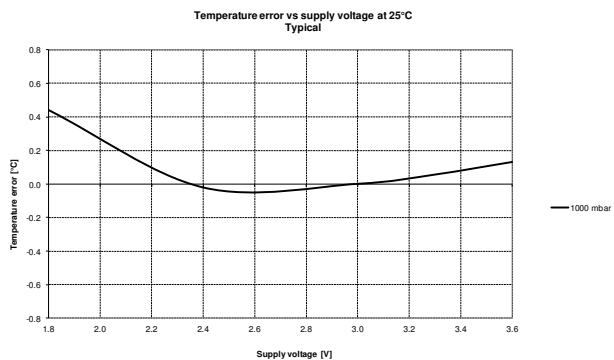
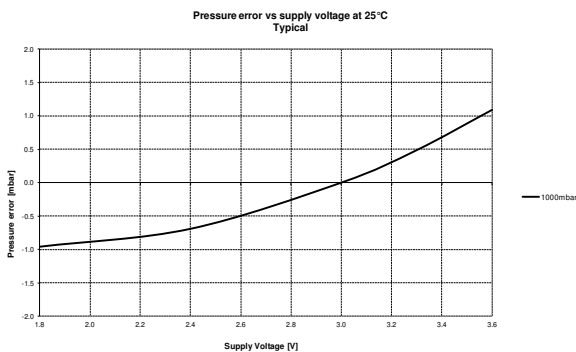

## FUNCTIONAL DESCRIPTION

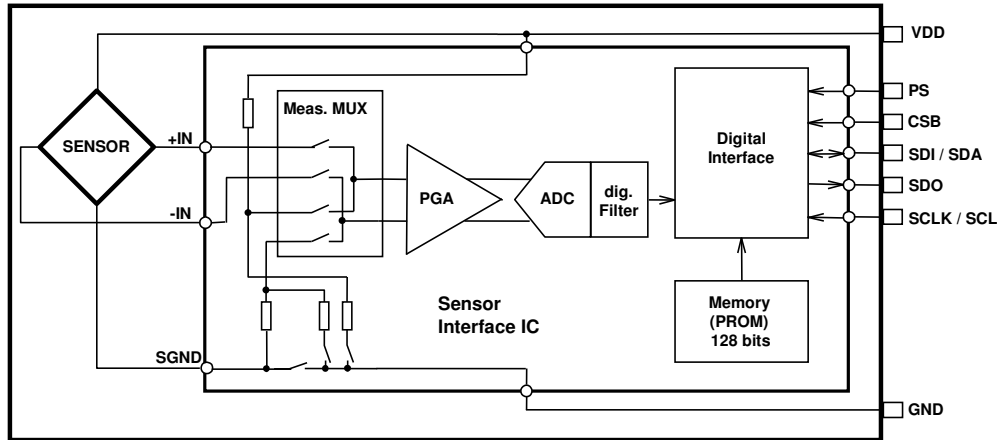

Figure 1: Block diagram of MS5803-01BA

### GENERAL

The MS5803-01BA consists of a piezo-resistive sensor and a sensor interface IC. The main function of the MS5803-01BA is to convert the uncompensated analogue output voltage from the piezo-resistive pressure sensor to a 24-bit digital value, as well as providing a 24-bit digital value for the temperature of the sensor.

### FACTORY CALIBRATION

Every module is individually factory calibrated at two temperatures and two pressures. As a result, 6 coefficients necessary to compensate for process variations and temperature variations are calculated and stored in the 128-bit PROM of each module. These bits (partitioned into 6 coefficients W1 to W6) must be read by the microcontroller software and used in the program converting D1 and D2 into compensated pressure and temperature values. The 2 coefficients W0 and W7 are for factory configuration and CRC.

### SERIAL INTERFACE

The MS5803-01BA has built in two types of serial interfaces: SPI and I<sup>2</sup>C. Pulling the Protocol Select pin PS to low selects the SPI protocol, pulling PS to high activates the I<sup>2</sup>C bus protocol.

Pin PS	Mode	Pins used
High	I <sup>2</sup> C	SDA, SCL, CSB
Low	SPI	SDI, SDO, SCLK, CSB

### SPI MODE

The external microcontroller clocks in the data through the input SCLK (Serial CLock) and SDI (Serial Data In). In the SPI mode module can accept both mode 0 and mode 3 for the clock polarity and phase. The sensor responds on the output SDO (Serial Data Out). The pin CSB (Chip Select) is used to enable/disable the interface, so that other devices can talk on the same SPI bus. The CSB pin can be pulled high after the command is sent or after the end of the command execution (for example end of conversion). The best noise performance from the module is obtained when the SPI bus is idle and without communication to other devices during the ADC conversion.

**I<sup>2</sup>C MODE**

The external microcontroller clocks in the data through the input SCLK (Serial CLock) and SDA (Serial DAta). The sensor responds on the same pin SDA which is bidirectional for the I<sup>2</sup>C bus interface. So this interface type uses only 2 signal lines and does not require a chip select, which can be favorable to reduce board space. In I<sup>2</sup>C-Mode the complement of the pin CSB (Chip Select) represents the LSB of the I<sup>2</sup>C address. It is possible to use two sensors with two different addresses on the I<sup>2</sup>C bus. The pin CSB shall be connected to VDD or GND (do not leave unconnected!).

Pin CSB	Address (7 bits)
High	0x76 (1110110 b)
Low	0x77 (1110111 b)

**COMMANDS**

The MS5803-01BA has only five basic commands:

1. Reset
2. Read PROM (128 bit of calibration words)
3. D1 conversion
4. D2 conversion
5. Read ADC result (24 bit pressure / temperature)

Size of each command is 1 byte (8 bits) as described in the table below. After ADC read commands the device will return 24 bit result and after the PROM read 16bit result. The address of the PROM is embedded inside of the PROM read command using the a2, a1 and a0 bits.

Bit number	Command byte								hex value
	0	1	2	3	4	5	6	7	
Bit name	PR M	COV	-	Typ	Ad2/ Os2	Ad1/ Os1	Ad0/ Os0	Stop	
Command									
Reset	0	0	0	1	1	1	1	0	0x1E
Convert D1 (OSR=256)	0	1	0	0	0	0	0	0	0x40
Convert D1 (OSR=512)	0	1	0	0	0	0	1	0	0x42
Convert D1 (OSR=1024)	0	1	0	0	0	1	0	0	0x44
Convert D1 (OSR=2048)	0	1	0	0	0	1	1	0	0x46
Convert D1 (OSR=4096)	0	1	0	0	1	0	0	0	0x48
Convert D2 (OSR=256)	0	1	0	1	0	0	0	0	0x50
Convert D2 (OSR=512)	0	1	0	1	0	0	1	0	0x52
Convert D2 (OSR=1024)	0	1	0	1	0	1	0	0	0x54
Convert D2 (OSR=2048)	0	1	0	1	0	1	1	0	0x56
Convert D2 (OSR=4096)	0	1	0	1	1	0	0	0	0x58
ADC Read	0	0	0	0	0	0	0	0	0x00
PROM Read	1	0	1	0	Ad2	Ad1	Ad0	0	0xA0 to 0xAE

Figure 2: Command structure



## I<sup>2</sup>C INTERFACE

### COMMANDS

Each I<sup>2</sup>C communication message starts with the start condition and it is ended with the stop condition. The MS5803-01BA address is 111011Cx, where C is the complementary value of the pin CSB. Since the IC does not have a microcontroller inside, the commands for I<sup>2</sup>C and SPI are quite similar.

### RESET SEQUENCE

The reset can be sent at any time. In the event that there is not a successful power on reset this may be caused by the SDA being blocked by the module in the acknowledge state. The only way to get the MS5803-01BA to function is to send several SCLKs followed by a reset sequence or to repeat power on reset.

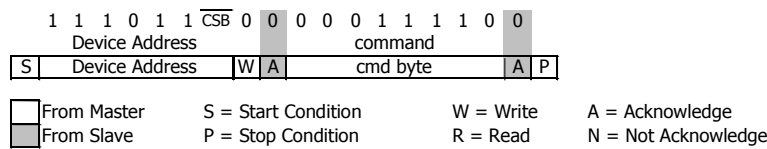

Figure 3: I<sup>2</sup>C Reset Command

### CONVERSION SEQUENCE

A conversion can be started by sending the command to MS5803-01BA. When command is sent to the system it stays busy until conversion is done. When conversion is finished, the data can be accessed by sending a Read command, when an acknowledge appears from the MS5803-01BA, 24 SCLK cycles may be sent to receive all result bits. Every 8 bit the system waits for an acknowledge signal.

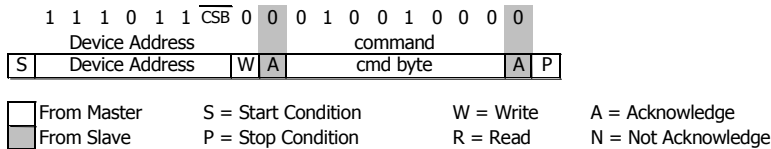

Figure 4: I<sup>2</sup>C Command to initiate a pressure conversion (OSR=4096, typ=D1)

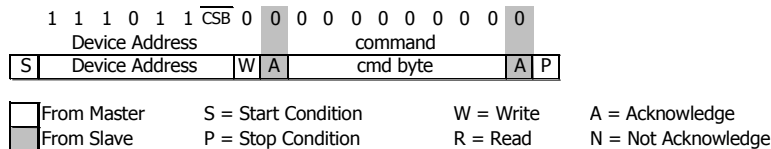

Figure 5: I<sup>2</sup>C ADC read sequence

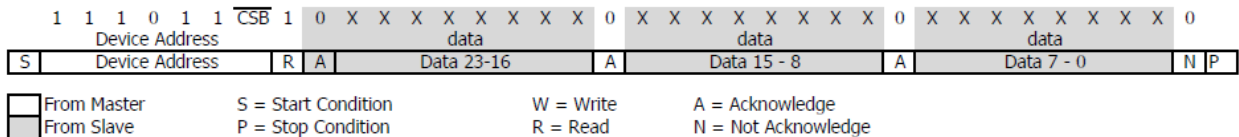

Figure 6: I<sup>2</sup>C pressure response (D1) on 24 bit from MS5803-01BA

**PROM READ SEQUENCE**

The PROM Read command consists of two parts. First command sets up the system into PROM read mode. The second part gets the data from the system.

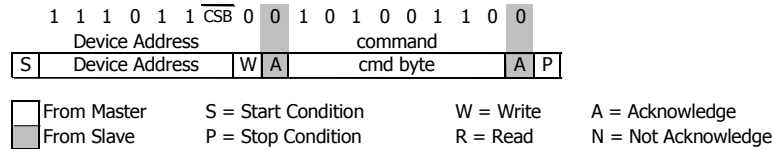

Figure 7: I<sup>2</sup>C Command to read memory address= 011 (Coefficient 3)

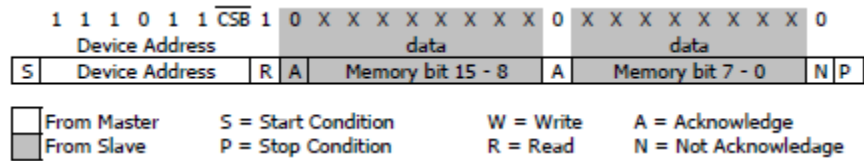

Figure 8: I<sup>2</sup>C answer from MS5803-01BA

**SPI INTERFACE**

**RESET SEQUENCE**

The Reset sequence shall be sent once after power-on to make sure that the calibration PROM gets loaded into the internal register. It can be also used to reset the device ROM from an unknown condition

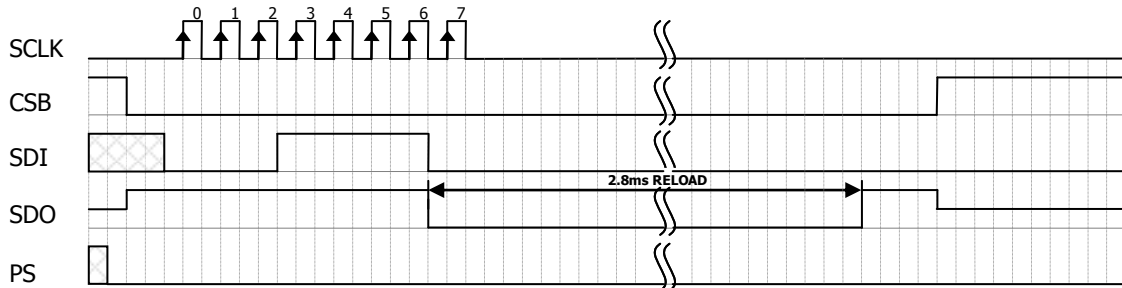

Figure 9: Reset command sequence SPI mode 0

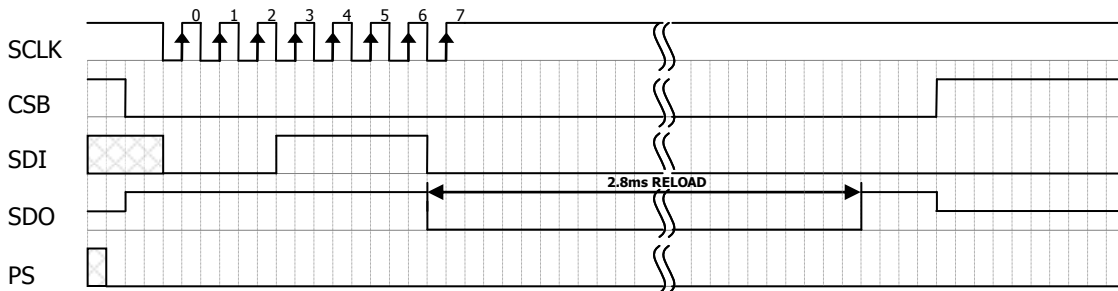

Figure 10: Reset command sequence SPI mode 3

**CONVERSION SEQUENCE**

The conversion command is used to initiate uncompensated pressure (D1) or uncompensated temperature (D2) conversion. The chip select can be disabled during this time to communicate with other devices. After the conversion, using ADC read command the result is clocked out with the MSB first. If the conversion is not executed before the ADC read command, or the ADC read command is repeated, it will give 0 as the output result. If the ADC read command is sent during conversion the result will be 0, the conversion will not stop and the final result will be wrong. Conversion sequence sent during the already started conversion process will yield incorrect result as well.

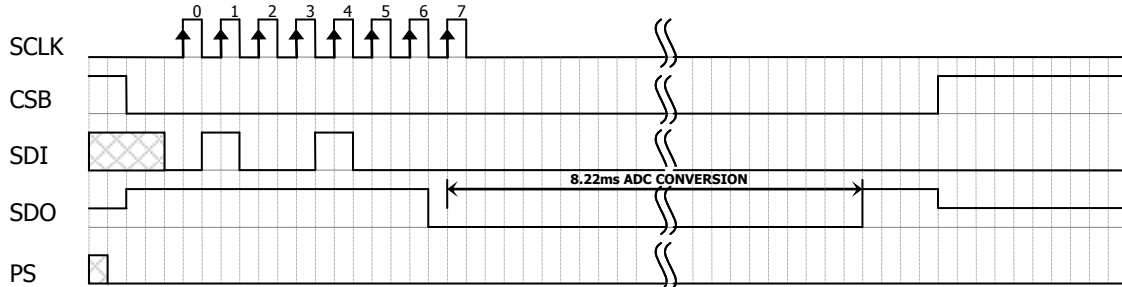

Figure 11: Conversion out sequence, Typ=d1, OSR = 4096

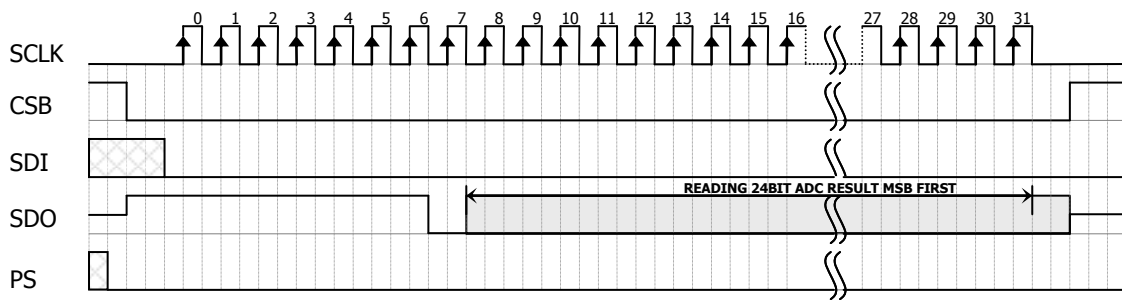

Figure 12: ADC Read sequence

**PROM READ SEQUENCE**

The read command for PROM shall be executed once after reset by the user to read the content of the calibration PROM and to calculate the calibration coefficients. There are in total 8 addresses resulting in a total memory of 128 bit. Address 0 contains factory data and the setup, addresses 1-6 calibration coefficients and address 7 contains the serial code and CRC. The command sequence is 8 bits long with a 16 bit result which is clocked with the MSB first.

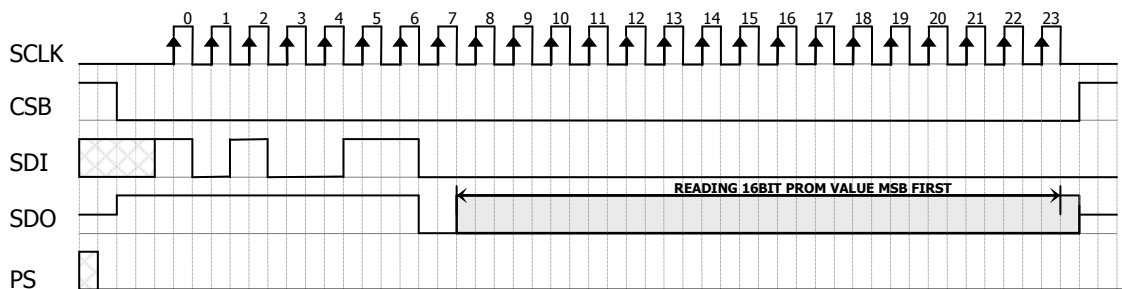

Figure 13: PROM Read sequence, address = 011 (Coefficient 3).

**CYCLIC REDUNDANCY CHECK (CRC)**

MS5803-01BA contains a PROM memory with 128-Bit. A 4-bit CRC has been implemented to check the data validity in memory. The application note AN520 describes in detail CRC-4 code used.

A	D	D	D	D	D	D	D	D	D	D	D	D	D	D	D	D
d	B	B	B	B	B	B	B	B	B	B	B	B	B	B	B	B
d	5	4	3	2	1	0	9	8	7	6	5	4	3	2	1	0
0	16 bit reserved for manufacturer															
1	Coefficient 1 (16 bit unsigned)															
2	Coefficient 2 (16 bit unsigned)															
3	Coefficient 3 (16 bit unsigned)															
4	Coefficient 4 (16 bit unsigned)															
5	Coefficient 5 (16 bit unsigned)															
6	Coefficient 6 (16 bit unsigned)															
7																CRC

Figure 14: Memory PROM mapping

**PRESSURE AND TEMPERATURE CALCULATION**

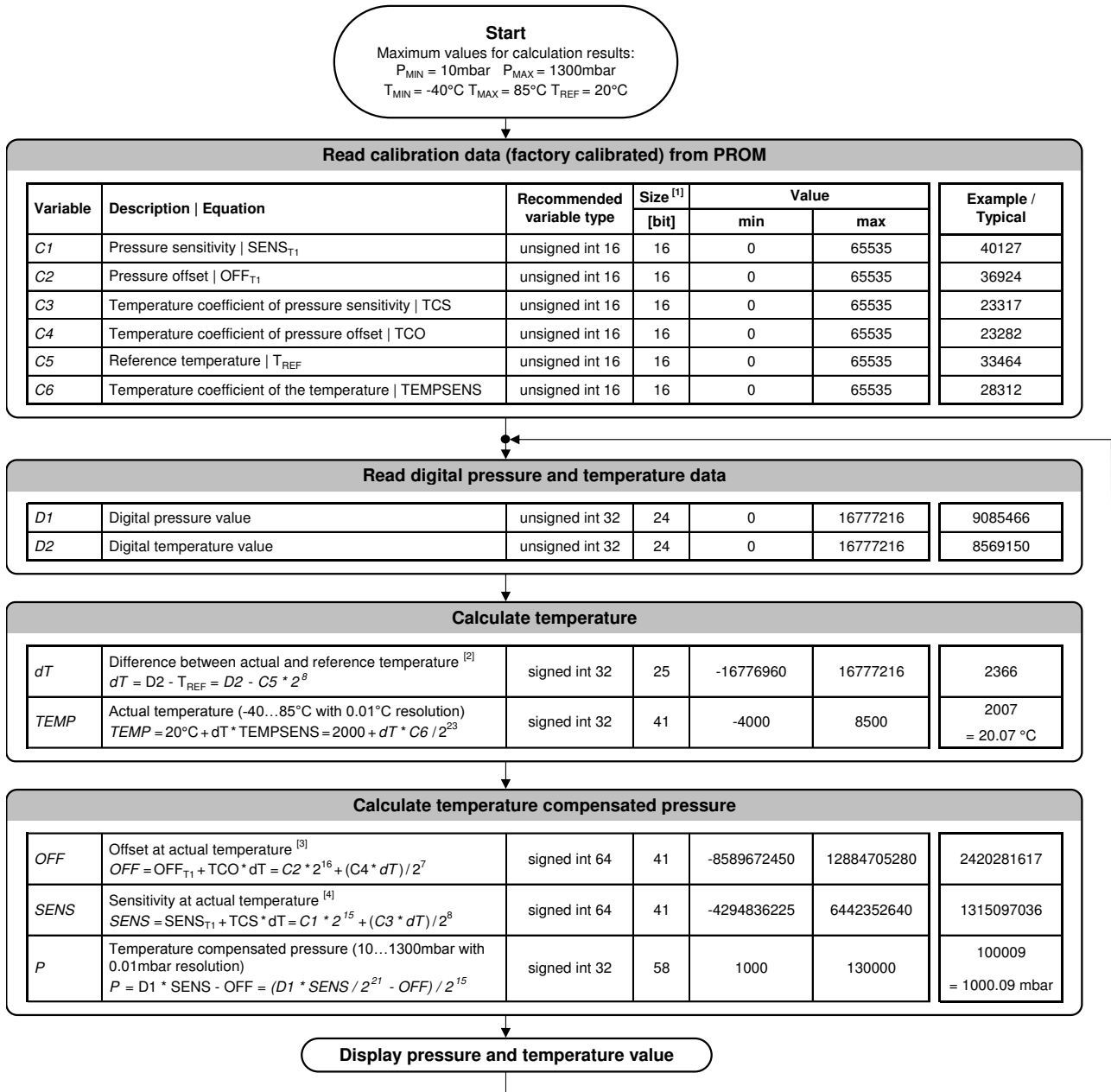

- Notes
- [1] Maximal size of intermediate result during evaluation of variable
  - [2] min and max have to be defined
  - [3] min and max have to be defined
  - [4] min and max have to be defined

Figure 15: Flow chart for pressure and temperature reading and software compensation.

**SECOND ORDER TEMPERATURE COMPENSATION**

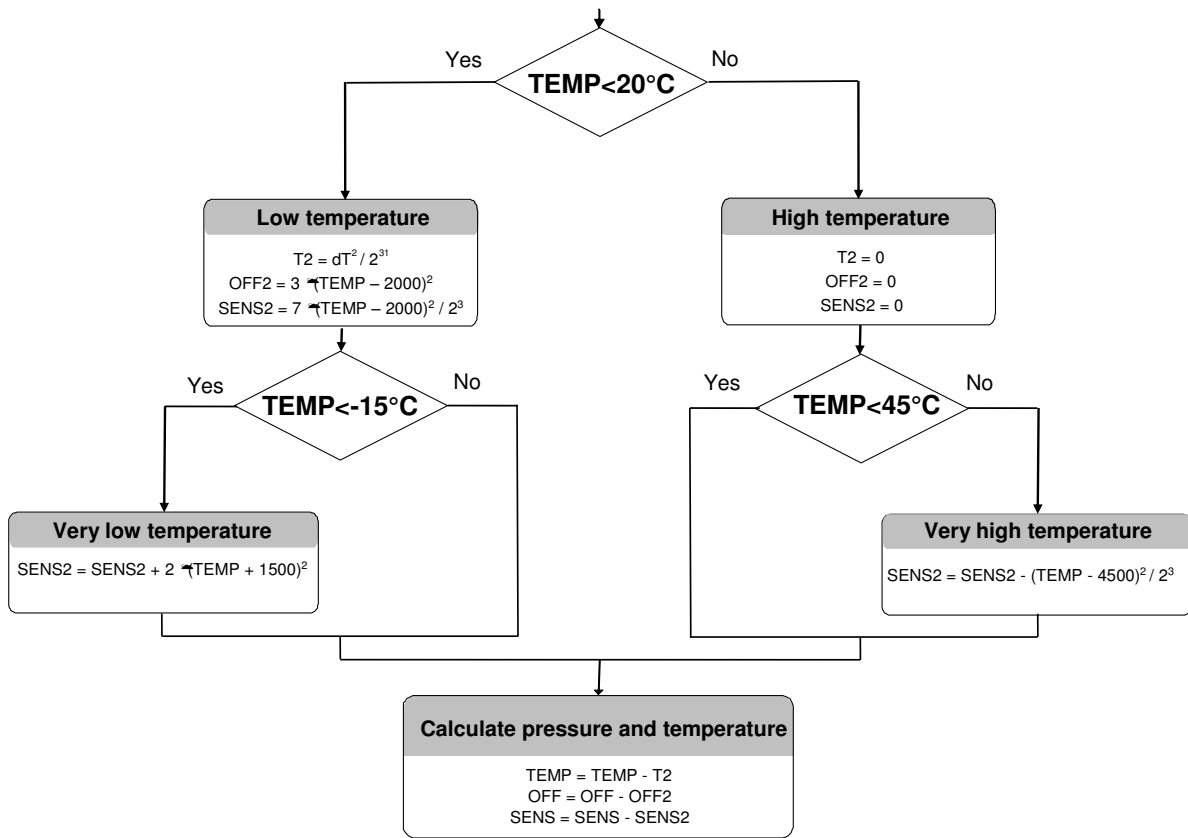

Figure 16: Flow chart for pressure and temperature to the optimum accuracy.

## APPLICATION CIRCUIT

The MS5803-01BA is a circuit that can be used in conjunction with a microcontroller in mobile altimeter applications. It is designed for low-voltage systems with a supply voltage of 3 V.

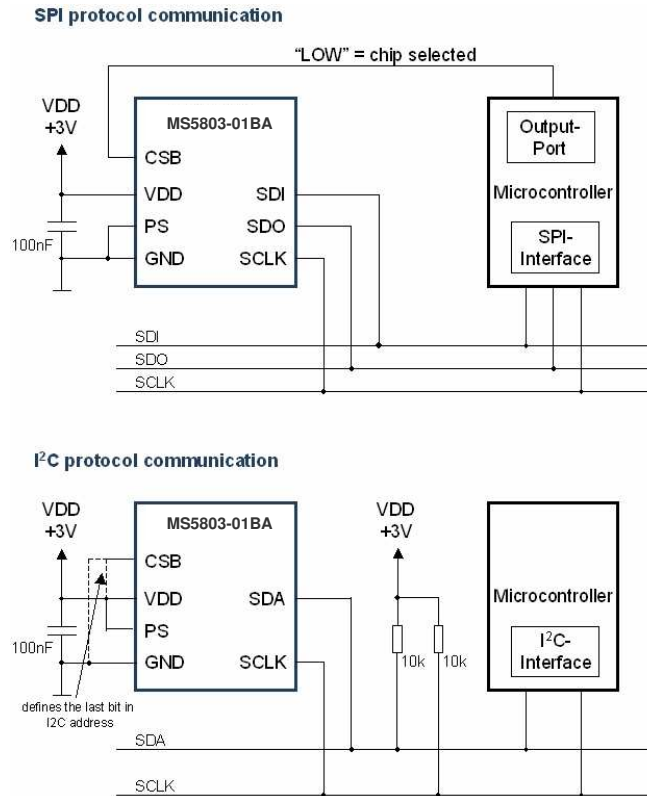

Figure 17: Typical application circuit with SPI / I<sup>2</sup>C protocol communication

**PACKAGE OUTLINE AND PIN CONFIGURATION**

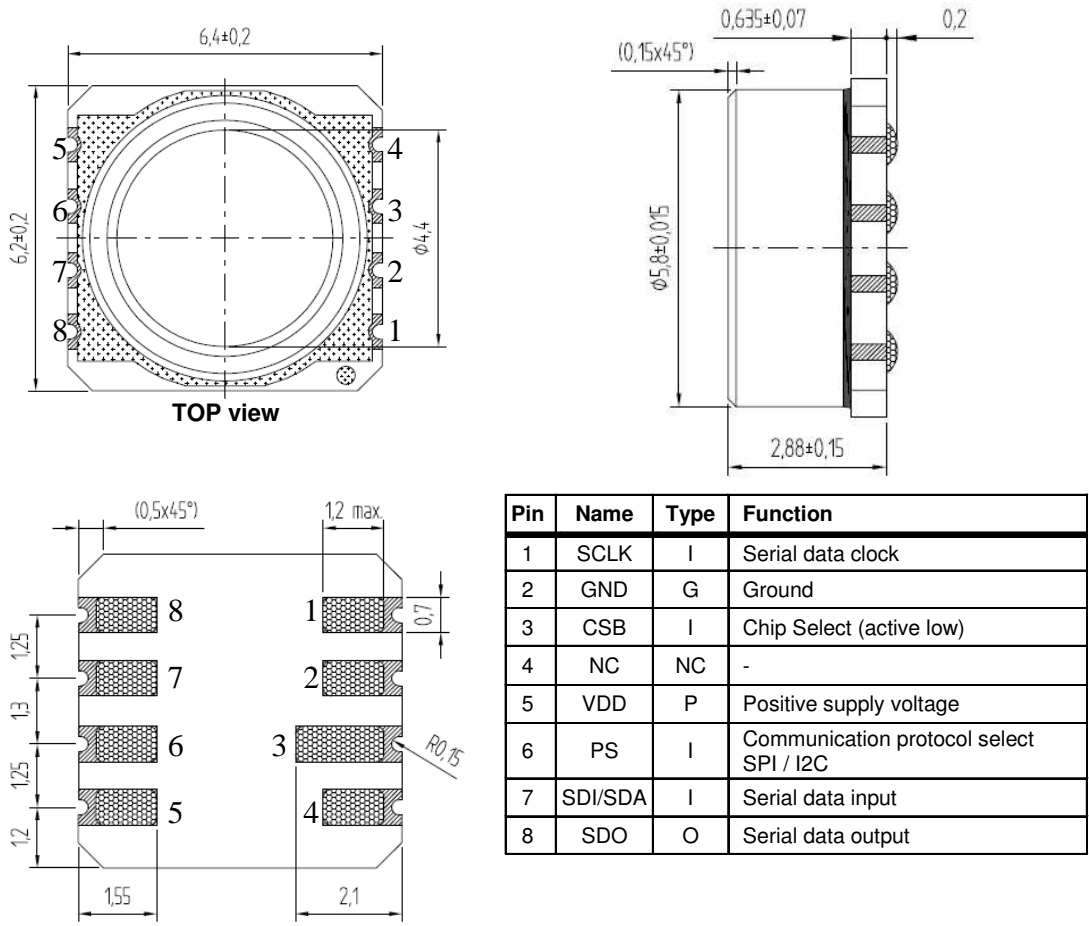
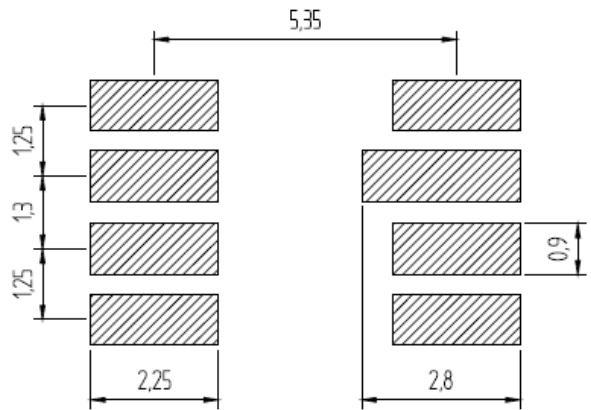

Figure 18: MS5803-01BA package outlines, pin configuration and description

- Notes:**
- (1) Dimensions in mm
  - (2) General tolerance  $\pm 0.1$
  - (3) Cap centering  $\pm 0.15$  from center of the ceramic

**RECOMMENDED PAD LAYOUT**





**SHIPPING PACKAGE**

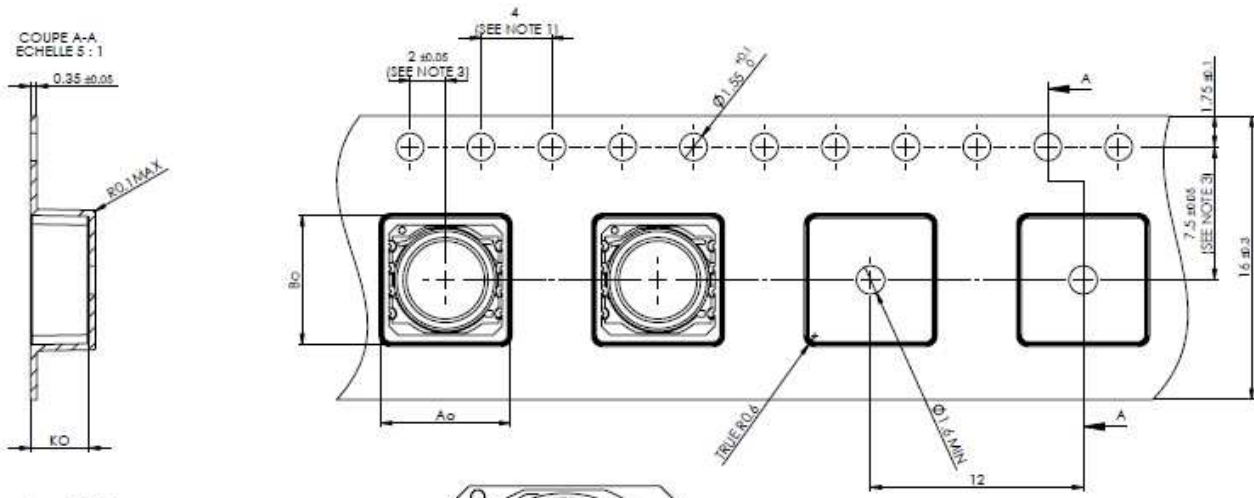
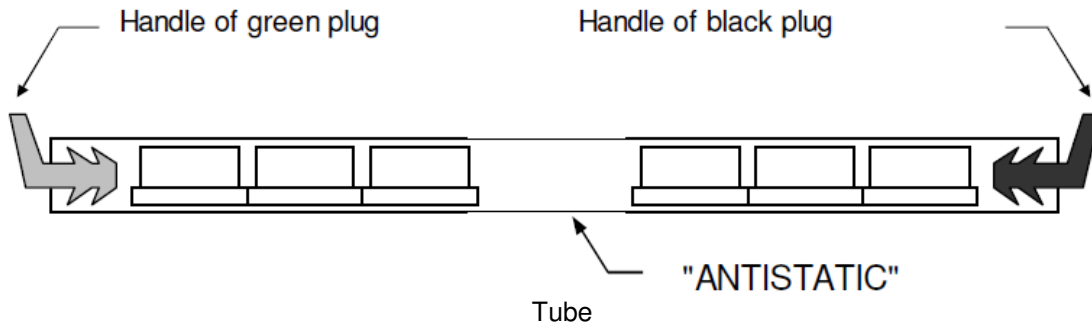
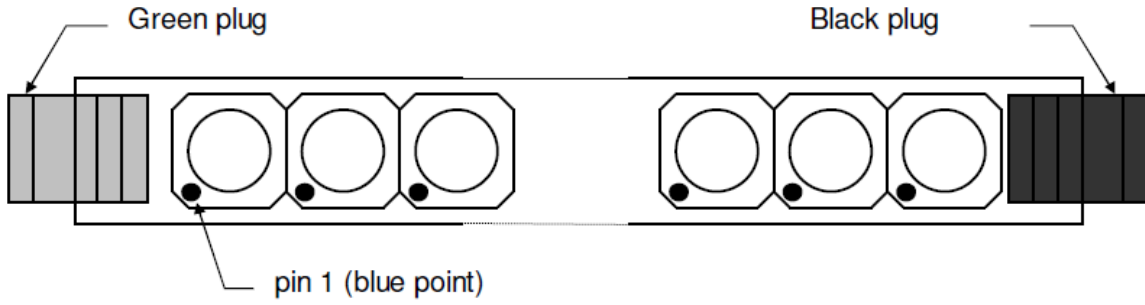

Ao=7.25  
Bo=7.25  
Ko=3.3

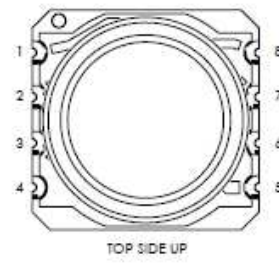

NOTE:  
1: 10 SPROCKET HOLE PITCH CUMULATIVE TOLERANCE ±0.2mm  
2: CAMBER IN COMPLIANCE WITH EIA 481  
3: POCKET POSITION RELATIVE TO SPROCKET HOLE MEASURED AS TRUE POSITION OF POCKET, NOT POCKET HOLE

Tape & reel

## MOUNTING AND ASSEMBLY CONSIDERATIONS

### **SOLDERING**

Please refer to the application note AN808 available on our website for all soldering issues.

### **MOUNTING**

The MS5803-01BA can be placed with automatic Pick & Place equipment using vacuum nozzles. It will not be damaged by the vacuum. Due to the low stress assembly the sensor does not show pressure hysteresis effects. It is important to solder all contact pads.

### **CONNECTION TO PCB**

The package outline of the module allows the use of a flexible PCB for interconnection. This can be important for applications in watches and other special devices.

### **SEALING WITH O-RINGS**

In products like outdoor watches the electronics must be protected against direct water or humidity. For those products the MS5803-01BA provides the possibility to seal with an O-ring. The protective cap of the MS5803-01BA is made of special anticorrosive stainless steel with a polished surface. In addition to this the MS5803-01BA is filled with silicone gel covering the sensor and the bonding wires. The O-ring (or O-rings) shall be placed at the outer diameter of the metal cap. This method avoids mechanical stress because the sensor can move in vertical direction.

### **CLEANING**

The MS5803-01BA has been manufactured under cleanroom conditions. It is therefore recommended to assemble the sensor under class 10'000 or better conditions. Should this not be possible, it is recommended to protect the sensor opening during assembly from entering particles and dust. To avoid cleaning of the PCB, solder paste of type "no-clean" shall be used. Cleaning might damage the sensor!

### **ESD PRECAUTIONS**

The electrical contact pads are protected against ESD up to 4 kV HBM (human body model). It is therefore essential to ground machines and personnel properly during assembly and handling of the device. The MS5803-01BA is shipped in antistatic transport boxes. Any test adapters or production transport boxes used during the assembly of the sensor shall be of an equivalent antistatic material.

### **DECOUPLING CAPACITOR**

Particular care must be taken when connecting the device to the power supply. A 100nF ceramic capacitor must be placed as close as possible to the MS5803-01BA VDD pin. This capacitor will stabilize the power supply during data conversion and thus, provide the highest possible accuracy.

## ORDERING INFORMATION

PART NUMBER	DESCRIPTION	Delivery Form
MS580301BA01-00	MS5803-01BA 1BAR White Gel	Tube
MS580301BA01-50	MS5803-01BA 1BAR White Gel T&R	Tape & Reel TOP-UP
MS580301BA06-00	MS5803-01BA1BAR White Gel HE	Tube
MS580301BA06-50	MS5803-01BA 1BAR White Gel HE T&R	Tape & Reel TOP-UP
MS580301BA06-10	MS5803-01BA 1BAR White Gel P-Caps (Protective cap)	Tray
MS580301BA06-60	MS5803-01BA 1BAR White Gel HE T&R P-Caps (Protective cap)	Tape & Reel TOP-UP

**PRODUCT DESCRIPTION**  
MS5803\_\_BA\_\_

**Pressure Range**

01	1 bar
----	-------

**Version**

00	Standard
06	High Endurance



**your distributor**  
**AMSYS GmbH & Co.KG**  
 An der Fahrt 4, 55124 Mainz, Germany  
 Tel. +49 (0) 6131 469 875 0  
 info@amsys.de | www.amsys.de

**NORTH AMERICA**

Measurement Specialties, Inc.,  
a TE Connectivity company  
Tel: 800-522-6752  
Email: [customercare.frmr@te.com](mailto:customercare.frmr@te.com)

**EUROPE**

Measurement Specialties (Europe), Ltd.,  
a TE Connectivity Company  
Tel: 800-440-5100  
Email: [customercare.bevx@te.com](mailto:customercare.bevx@te.com)

**ASIA**

Measurement Specialties (China) Ltd.,  
a TE Connectivity company  
Tel: 0400-820-6015  
Email: [customercare.shzn@te.com](mailto:customercare.shzn@te.com)

**TE.com/sensorsolutions**

Measurement Specialties, Inc., a TE Connectivity company.

Measurement Specialties, TE Connectivity, TE Connectivity (logo) and EVERY CONNECTION COUNTS are trademarks. All other logos, products and/or company names referred to herein might be trademarks of their respective owners.

The information given herein, including drawings, illustrations and schematics which are intended for illustration purposes only, is believed to be reliable. However, TE Connectivity makes no warranties as to its accuracy or completeness and disclaims any liability in connection with its use. TE Connectivity's obligations shall only be as set forth in TE Connectivity's Standard Terms and Conditions of Sale for this product and in no case will TE Connectivity be liable for any incidental, indirect or consequential damages arising out of the sale, resale, use or misuse of the product. Users of TE Connectivity products should make their own evaluation to determine the suitability of each such product for the specific application.

© 2015 TE Connectivity Ltd. family of companies All Rights Reserved.