

## Features

- High-resolution pressure sensor
- Fast conversion down to 0.37 ms
- Low power down to 0.34  $\mu\text{A}$  (standby < 0.1  $\mu\text{A}$  at 25°C)
- Ceramic package 3.3 x 3.3 x 2.7 mm<sup>3</sup>
- Supply voltage 1.5 V to 3.6 V
- Integrated digital pressure sensor (24-bit  $\Delta\Sigma$  ADC)
- Operating range: 300 to 30000 mbar, -40°C/+110 °C
- SPI and I<sup>2</sup>C interfaces
- No external components (internal oscillator)
- Excellent long-term stability
- Built-in automatic conversion
- Signaling state by interrupt
- Programmable filter
- Built-in FIFO
- 64-bit serial number

## Applications

- SAFETY Devices in Sea Water
- MEDICAL Portable Devices
- Disposable - Drug TREATMENT
- Mildly Corrosive gases in SEMICON
- Liquid measurement

# MS5849-30BA

Ultra-compact, chlorine resistant, absolute pressure sensor

## Description

The MS5849 is a new generation of high-resolution pressure sensors from TE Connectivity with SPI / I<sup>2</sup>C bus interface.

The pressure sensor includes a high linearity pressure sensor and an ultra-low power 24-bit  $\Delta\Sigma$  ADC with internal factory calibrated coefficients. It provides precise digital 24-bit pressure and temperature values and different operation modes that allow the user to optimize for conversion speed and current consumption. The MS5849 can be interfaced to virtually any microcontroller.

Its small dimensions of 3.3 mm x 3.3 mm x 2.7 mm and its low power consumption allow easy integration in user applications. This new sensor generation is based on leading MEMS technology and latest benefits from TE proven experience and know-how in high volume manufacturing of pressure sensors, which have been widely used for over three decades.

**TABLE OF CONTENTS**

<b>PERFORMANCE SPECIFICATIONS</b> .....	<b>4</b>
Absolute Maximum Ratings .....	4
ENVIRONMENTAL PARAMETERS.....	4
Electrical Characteristics .....	5
Analog Digital Converter (ADC).....	5
Pressure output characteristics.....	6
Temperature output characteristics.....	6
Digital Inputs (SCL, SDA, CSB, I2C) .....	7
Digital Outputs (SDA, SDO, INT) .....	7
<b>TYPICAL PERFORMANCE CHARACTERISTICS</b> .....	<b>8</b>
Pressure and Temperature Error vs Temperature .....	8
Pressure and Temperature Error vs Pressure .....	8
Pressure and Temperature Drift vs Supply Voltage .....	8
<b>PRESSURE AND TEMPERATURE ACQUISITION</b> .....	<b>9</b>
General .....	9
Factory Calibration .....	9
Basic Procedure .....	9
First Order Pressure and Temperature Calculation .....	10
Second Order Pressure and Temperature Compensation .....	11
<b>POWER ON (PON)</b> .....	<b>12</b>
<b>MEMORY (NVM) MAPPING</b> .....	<b>12</b>
<b>CONFIGURATION REGISTER</b> .....	<b>13</b>
<b>OPERATION REGISTER</b> .....	<b>14</b>
<b>AUTOMATIC MODE</b> .....	<b>15</b>
<b>FILTER</b> .....	<b>15</b>
<b>FIFO OPERATION</b> .....	<b>16</b>
<b>INTERRUPT</b> .....	<b>18</b>
Limit registers for raw pressure and temperature .....	19
<b>SERIAL INTERFACES</b> .....	<b>20</b>
Command structure .....	20
<i>SPI Interface</i> .....	21
Power On Behavior.....	22
Reset.....	22
Write Configuration .....	23
Read Configuration.....	23
Read Memory.....	24
Start Conversion .....	24
Read ADC Register .....	25

Write Operation Register.....	26
Read Operation Register.....	26
Write Interrupt Mask.....	27
Read Interrupt Mask.....	27
Write Interrupt Register.....	28
Read Interrupt Register.....	28
Write Limit Register.....	29
Read Limit Register.....	29
<i>I<sup>2</sup>C Interface.....</i>	<i>30</i>
Reset.....	31
Write Configuration.....	31
Read Configuration.....	32
Read Memory.....	33
Start Conversion.....	34
Read ADC Register.....	35
Write Operation Register.....	35
Read Operation Register.....	36
Write Interrupt Mask.....	37
Read Interrupt Mask.....	37
Write Interrupt Register.....	38
Read Interrupt Register.....	38
Write Limit Register.....	39
Read Limit Register.....	40
<b>CYCLIC REDUNDANCY CHECK (CRC).....</b>	<b>41</b>
8 Bits CRC Calculation Flow Chart.....	42
<b>PIN CONFIGURATION AND DEVICE PACKAGE OUTLINE.....</b>	<b>44</b>
Back engraving.....	44
<b>WETTED MATERIALS.....</b>	<b>45</b>
<b>RECOMMENDED PAD LAYOUT.....</b>	<b>45</b>
<b>SHIPPING PACKAGE.....</b>	<b>46</b>
Tape Information.....	46
Reel Information.....	47
<b>MOUNTING AND ASSEMBLY CONSIDERATIONS.....</b>	<b>48</b>
Soldering.....	48
Mounting.....	48
Connection to PCB.....	48
Sealing with O-Ring.....	48
Cleaning.....	49
ESD Precautions.....	49
Decoupling Capacitor.....	49

## MS5849-30BA

Ultra-compact, chlorine resistant, absolute pressure sensor

### PERFORMANCE SPECIFICATIONS

#### ABSOLUTE MAXIMUM RATINGS

Parameter	Symbol	Conditions	Min.	Typ.	Max.	Unit
Supply Voltage	V <sub>DD</sub>		-0.3		+3.6	V
Overpressure	P <sub>max</sub>	ISO 22810 / 6425			50	bar
Maximum Soldering Temperature	T <sub>max</sub>	IPC/JEDEC J-STD-020E			250	°C
Moisture Sensitivity Level	MSL	IPC/JEDEC J-STD-020E		1		
ESD	ESD	Human Body Model	-8		+8	kV
Latch up		JEDEC JESD78F	-100		100	mA

#### ENVIRONMENTAL PARAMETERS

Parameter	Symbol	Conditions	Min.	Typ.	Max.	Unit
Storage Temperature	T <sub>s</sub>		-40		+125	°C
Operating Temperature	T		-40	+25	+110	°C
Compensated Temperature Range			-20		85	°C
Chlorine Exposure Cycling	Cl	Exposure time to Cl <sub>(aq)</sub> (10ppm)			6	Hrs.
		Drying after exposure (60°C/60%RH)	16			Hrs.
Shocks	S	JESD22-B104C Service condition A			500	g
Vibration	VIB	JESD22-B103B Service condition 3			3	g

**PERFORMANCE SPECIFICATIONS (CONTINUED)**

**ELECTRICAL CHARACTERISTICS**

Parameter	Symbol	Conditions		Min.	Typ.	Max.	Unit
Operating Supply Voltage	V <sub>DD</sub>			1.5	3.0	3.6	V
Supply Current (1 sample per sec.)	I <sub>DD</sub>	OSR	6		16.74		μA
			5		8.41		
			4		4.25		
			3		2.16		
			2		1.12		
			1		0.60		
			0		0.34		
Peak Supply Current		during conversion			1.17		mA
Standby Supply Current		at 25°C (V <sub>DD</sub> = 3.0V)			0.02	0.1	μA
VDD Capacitor		From V <sub>DD</sub> to GND			100		nF

**ANALOG DIGITAL CONVERTER (ADC)**

Parameter	Symbol	Conditions		Min.	Typ.	Max.	Unit
Output Word					24		bit
Conversion Time <sup>(1)</sup>	t <sub>c</sub>	OSR	6	14.76	16.40	18.04	ms
			5	7.41	8.24	9.07	
			4	3.74	4.16	4.58	
			3	1.90	2.12	2.34	
			2	1.00	1.10	1.22	
			1	0.53	0.59	0.65	
			0	0.29	0.33	0.37	

<sup>(1)</sup> Maximum values must be used to determine waiting times in I<sup>2</sup>C communication

**PERFORMANCE SPECIFICATIONS (CONTINUED)**

**PRESSURE OUTPUT CHARACTERISTICS (VDD = 3 V, T = 25°C UNLESS OTHERWISE NOTED)**

Parameter	Conditions		Min.	Typ.	Max.	Unit
Operating Pressure Range	P <sub>range</sub>	Full Accuracy	300		30 000	mbar
Absolute Accuracy <sup>(2)</sup> Temperature Range: 0 ... 60°C	850 ... 10 000 mbar		-50		+50	mbar
	850 ... 20 000 mbar		-100		+100	
	850 ... 30 000 mbar		-175		+175	
Absolute Accuracy <sup>(2)</sup> Temperature Range: -20 ... 85°C	850 ... 10 000 mbar		-100		+100	mbar
	850 ... 20 000 mbar		-150		+150	
	850 ... 30 000 mbar		-225		+225	
Maximum Error with Supply Voltage <sup>(3)</sup>	V <sub>DD</sub> = 1.5 V ... 3.6 V, at 20°C			±30		mbar
Long-term Stability				±30		mbar/yr
Reflow Soldering Impact	IPC/JEDEC J-STD-020E			±10		mbar
Recovering Time after Reflow <sup>(4)</sup>				1		day
Resolution RMS	OSR	6		0.14		mbar
		5		0.19		
		4		0.27		
		3		0.38		
		2		0.55		
		1		0.79		
		0		1.31		

**TEMPERATURE OUTPUT CHARACTERISTICS (VDD = 3 V, T = 25°C UNLESS OTHERWISE NOTED)**

Parameter	Conditions		Min.	Typ.	Max.	Unit
Absolute Accuracy Pressure Range: 850...30000 mbar	0°C ... 60°C		-1.3		+1.3	°C
	-20°C ... +85°C		-2		+2	
Maximum Error with Supply Voltage <sup>(3)</sup>	V <sub>DD</sub> = 1.5 V ... 3.6 V, at 20°C			±0.6		°C
Resolution RMS	OSR	6		0.0009		°C
		5		0.0009		
		4		0.0011		
		3		0.0015		
		2		0.0020		
		1		0.0030		
		0		0.0062		

(2) Wet/dry cycle: the sensor must be dried typically once a day.

(3) With autozero at 3V point.

(4) Time to recover at least 66% of the reflow impact.

**PERFORMANCE SPECIFICATIONS (CONTINUED)****DIGITAL INPUTS (SCL, SDA, CSB, I2C)**

Parameter	Symbol	Conditions	Min.	Typ.	Max.	Unit
Serial Data Clock I2C	SCL				3.4	MHz
Serial Data Clock SPI				10	20 <sup>(5)</sup>	MHz
Input High Voltage	V <sub>IH</sub>		80% V <sub>DD</sub>		100% V <sub>DD</sub>	V
Input Low Voltage	V <sub>IL</sub>		0% V <sub>DD</sub>		20% V <sub>DD</sub>	V
Input Leakage Current	I <sub>leak25°C</sub>	at 25°C		0.01	0.14	μA
	I <sub>leak85°C</sub>	at 85°C		0.25	1.40	μA
CS low to first SCL rising	t <sub>CSL</sub>		21			ns
CS high from last SCL falling	t <sub>CSH</sub>		21			ns
SDI setup to first SCL rising	t <sub>DSO</sub>		6			ns
SDI hold from SCL rising	t <sub>DO</sub>		6			ns

**DIGITAL OUTPUTS (SDA, SDO, INT)**

Parameter	Symbol	Conditions	Min.	Typ.	Max.	Unit
Output High Voltage	V <sub>OH</sub>	I <sub>source</sub> = 0.5 mA	80% V <sub>DD</sub>		100% V <sub>DD</sub>	V
Output Low Voltage	V <sub>OL</sub>	I <sub>sink</sub> = 0.5 mA	0% V <sub>DD</sub>		20% V <sub>DD</sub>	V

<sup>(5)</sup> Depending on the bus capacitive load

**TYPICAL PERFORMANCE CHARACTERISTICS**

**PRESSURE AND TEMPERATURE ERROR VS TEMPERATURE**

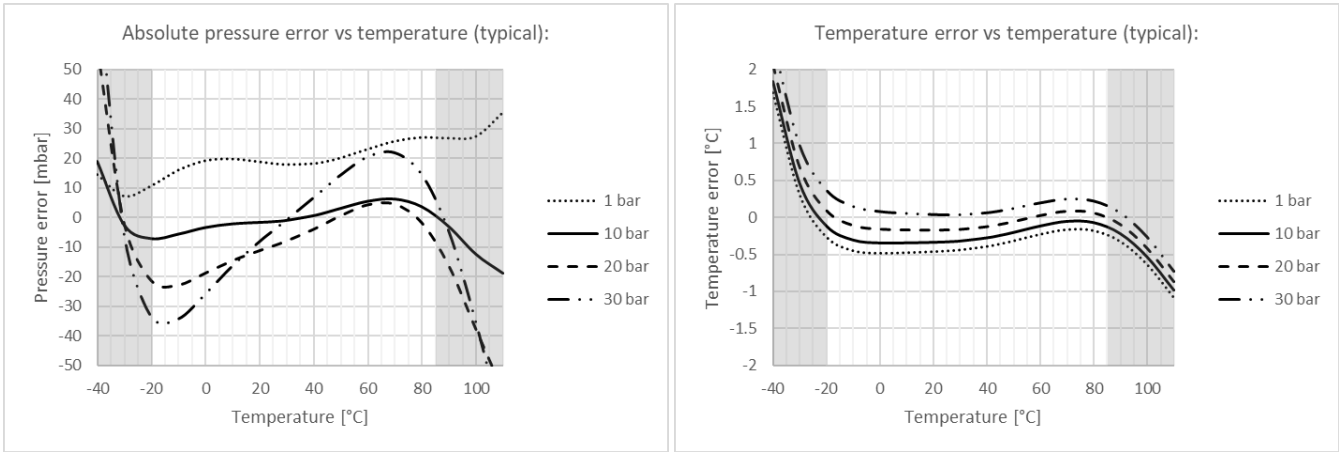

**PRESSURE AND TEMPERATURE ERROR VS PRESSURE**

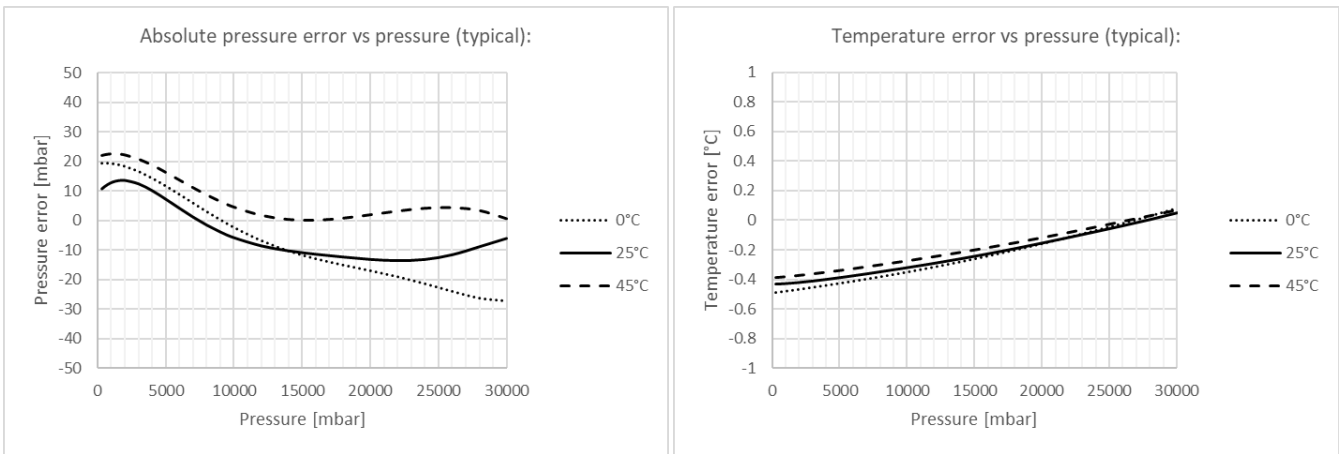

**PRESSURE AND TEMPERATURE DRIFT VS SUPPLY VOLTAGE**

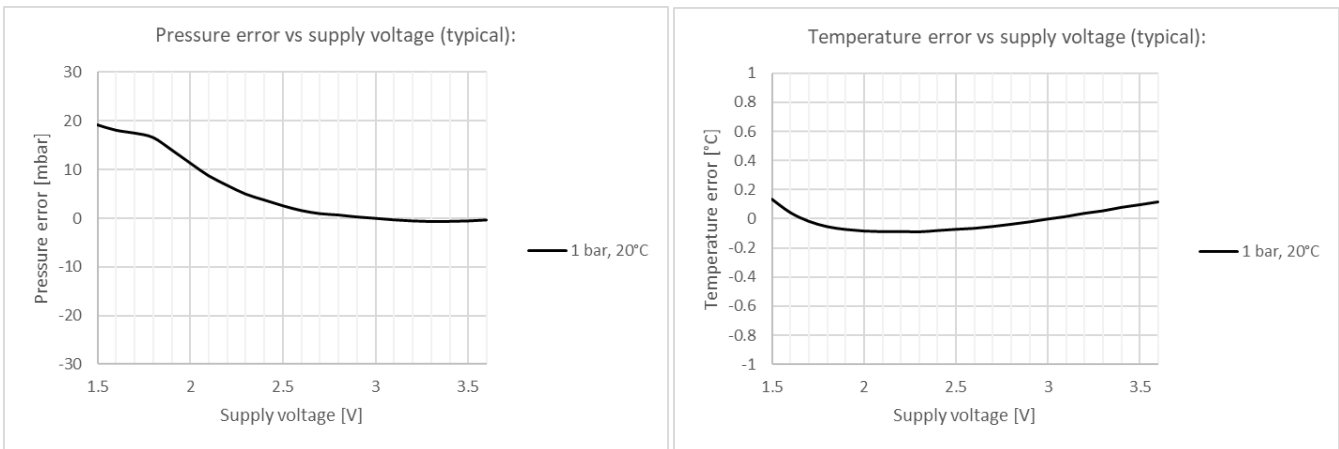



## PRESSURE AND TEMPERATURE ACQUISITION

### GENERAL

The MS5849 consists of a piezo-resistive sensing element and an interface IC. The main function of the MS5849 is to provide a raw digital pressure and temperature representation out of the uncompensated analog output voltage from the piezo-resistive sensing element. The raw digital values can then be converted into a compensated pressure and temperature using factory calibration data and appropriate computation formula.

### FACTORY CALIBRATION

Every pressure sensor is individually factory calibrated. As a result, 10 coefficients necessary to compensate for process and temperature variations are calculated and stored in the 256-bit NVRAM of each pressure sensor. These coefficients (stored in 16-bit words from W4 to W13) must be read and used together with the D1 and D2 values to calculate the compensated pressure and temperature values.

See [Memory \(NVM\) Mapping section](#) for additional information.

### BASIC PROCEDURE

1. Set Configuration Register  
Please see the [Configuration Register section](#) for additional information.  
The configuration register is reset after any power down event or reset command.
2. Read memory content  
This must be done at least once to collect factory calibration coefficients from memory. See [Memory \(NVM\) Mapping section](#) for additional information.
3. Start conversion  
Send a start conversion command. See [Start Conversion section \(SPI\)](#) or [Start Conversion section \(I<sup>2</sup>C\)](#) for additional information.
4. Read ADC register  
When a conversion is completed, the raw digital pressure value D1 and the raw digital temperature value D2 can be read from the ADC register. See [Read ADC register section \(SPI\)](#) or [Read ADC register section \(I<sup>2</sup>C\)](#) for additional information.
5. Calculate the compensated pressure and temperature values. See next part for additional information.

PRESSURE AND TEMPERATURE ACQUISITION (CONTINUED)

FIRST ORDER PRESSURE AND TEMPERATURE CALCULATION

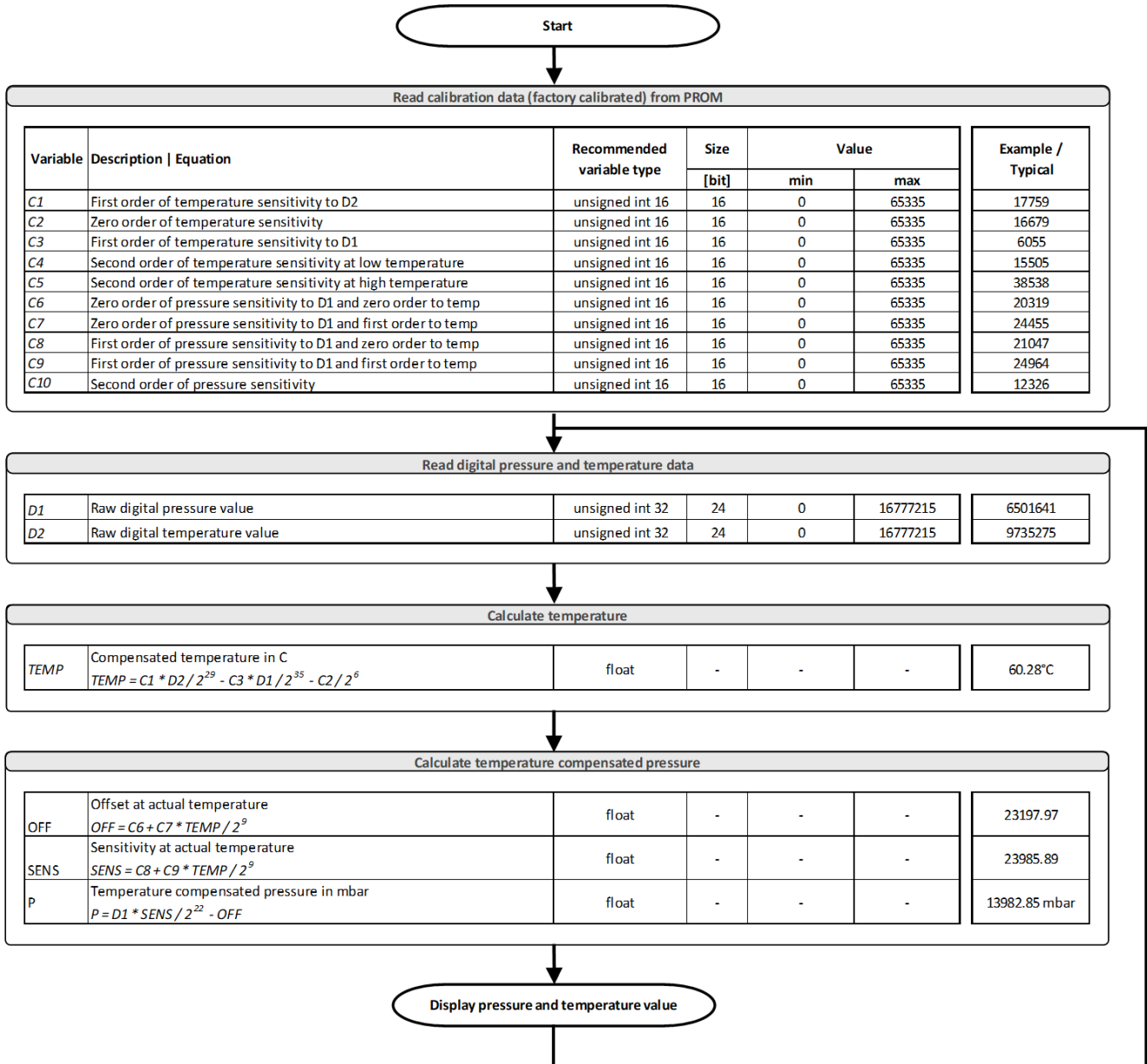
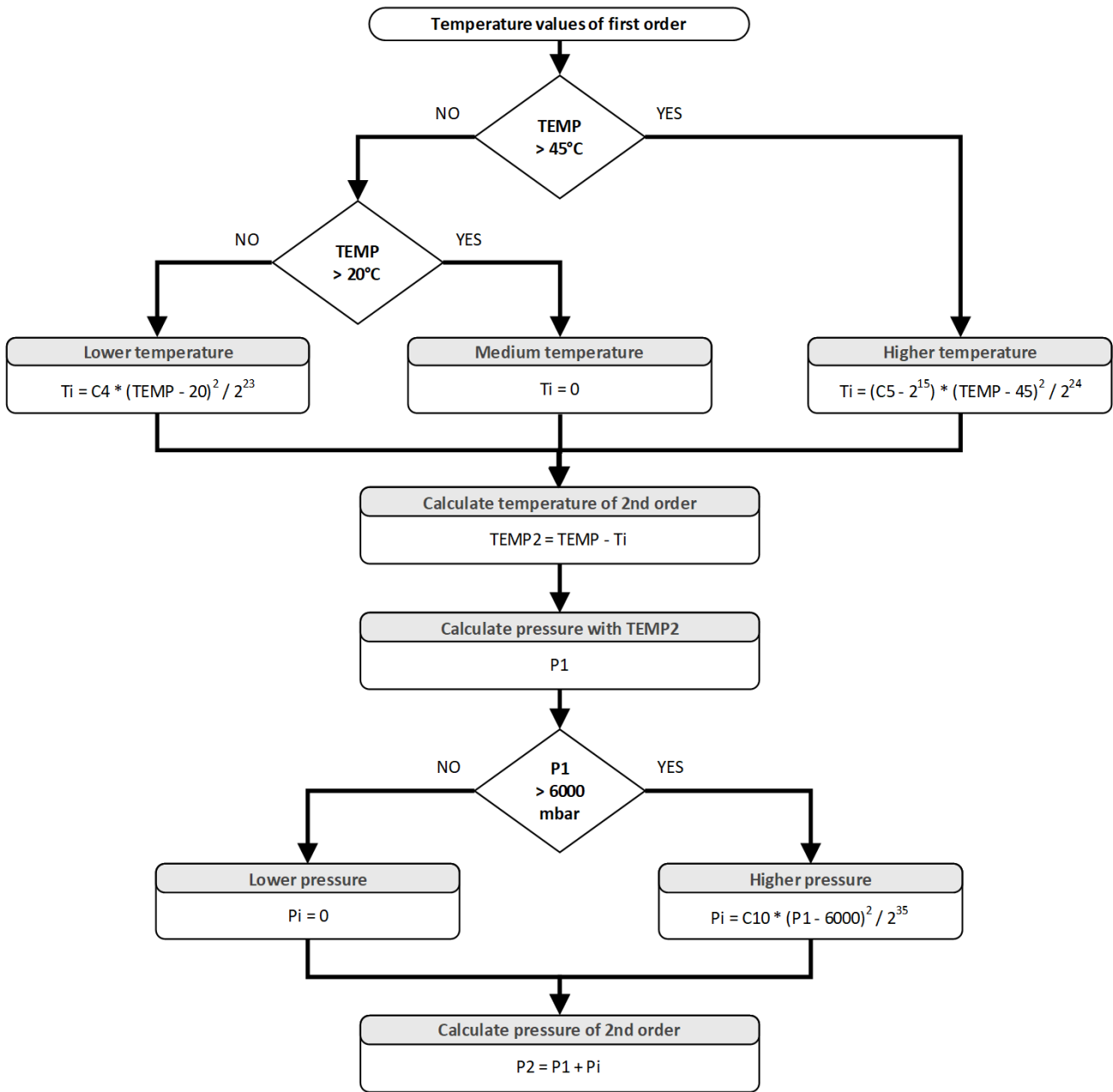

Figure 1: Flow chart for pressure and temperature calculation and compensation.

**PRESSURE AND TEMPERATURE ACQUISITION (CONTINUED)**

**SECOND ORDER PRESSURE AND TEMPERATURE COMPENSATION**



**Figure 2:** Flow chart for pressure and temperature to the optimum accuracy.

## MS5849-30BA

Ultra-compact, chlorine resistant, absolute pressure sensor

### POWER ON (PON)

The MS5849 has a built-in power on circuit (PON). After the power up, the digital block will be in reset state and the NVM values are loaded into the digital part. This sequence lasts about 100 to 260  $\mu$ s. During the power on sequence, SDO is pulled low. Once initialization finished SDO goes high again to signal the chip is ready for operation. The same procedure of data reload will happen after a reset command.

### MEMORY (NVM) MAPPING

Memory bits on the address 0 and 1 are reserved for the IC setting behavior. The memory is displayed as seen from the SPI and I<sup>2</sup>C interface.

Address	15	14	13	12	11	10	9	8	7	6	5	4	3	2	1	0
0	Reserved															
1	Reserved															
2	Serial number [31:16]															
3	Serial number [15:0]															
4	C1 [15:0]															
5	C2 [15:0]															
6	C3 [15:0]															
7	C4 [15:0]															
8	C5 [15:0]															
9	C6 [15:0]															
10	C7 [15:0]															
11	C8 [15:0]															
12	C9 [15:0]															
13	C10 [15:0]															
14	Reserved															
15	Product ID [15:8]								CRC [7:0]							

**Table 1:** Memory mapping.

**Serial number** - Serial number assigned during calibration

**C1 to C10** - Coefficients defined during factory calibration of each single sensor used to calculate compensated pressure and temperature

**Product ID** - Product identifier = 0x01

**CRC [7:0]** - CRC value of memory

**CONFIGURATION REGISTER**

The analog-to-digital conversion of the pressure and temperature can be individually configured using the read/write configuration register. The configuration commands work with 16 bits parameter defined as follow:

T/P config register	D[15:11]	D[10:8]	D[7:5]	D[4:3]	D[(2:0]
default	00000	000	000	00	000
code	Reserved	Ratio	Filter	Resolution	OSR
000		off	off	24 bits	0
001		1	2	16 bits	1
010		2	4	8 bits	2
011		4	8	8 bits	3
100		8	16		4
101		16	32		5
110		32	32		6
111		32	32		6

**Table 2:** Configuration Register.

- Ratio** – defines different combination of conversion ratios for temperature and pressure. This is useful when the pressure sensor is used in automatic mode. See [Automatic Mode section](#) for additional information.
- Filter** – Filter coefficient of the moving average. See [Filter section](#) for additional information.
- Resolution** – defines the number of bits sent when a read ADC command is executed.
- OSR** – defines the oversampling ratio. OSR=6 is the best resolution but the longest conversion time. See [Performance Specification section](#) for additional information.

**OPERATION REGISTER**

The operation register allows to set various modes like the FIFO mode and the delay in automatic measurement mode.

Operation register	D[15:13]	D[12:8]	D[7:6]	D[5:4]	D[3:0]
Default	000	00000	00	00	0000
<b>Code</b>	<b>Not used</b>	<b>FIFO interrupt threshold</b>	<b>FIFO mode</b>	<b>Not used</b>	<b>Delay</b>
0: 0000		off	off		off
1: 0001		1	full mode		5 ms
2: 0010		2	update mode		10 ms
3: 0011		3			20 ms
4: 0100		4			50 ms
5: 0101		5			0.1 sec
6: 0110		6			0.2 sec
7: 0111		7			0.5 sec
8: 1000		8			1 sec
9: 1001		9			2 sec
A: 1010		10			5 sec
B: 1011		11			10 sec
C: 1100		12			20 sec
D: 1101		13			60 sec
↓		↓			↓
1F: 11111		31			60 sec

**Table 3:** Operation Register Content.

- FIFO interrupt threshold** – triggers the interrupt if n measurements are ready in the FIFO
- FIFO mode** – is the FIFO operation: 0 = off; 1 = stop at FIFO full; 2,3 = overwrite at FIFO full
- Delay** – is the time between automatically triggered measurements

**Delay** bits [3:0] configures the time between the first measurement finished and the next is started. The measurements can be understood as a pressure and/or temperature conversions, depending on the ratio configuration. The automatic mode does not start if the ratio of p and T are off in the configuration register.

During automatic measurement all user commands are accepted, except ‘conversion’ and ‘write config’ command. Automatic mode can be stopped by setting the **Delay** = off. In case that an already started conversion is running, the automatic triggering of new conversion will be stopped, but the started conversions will finish and the ratio counter will be reset, after completing the requested started set of measurements (p, T).

As soon as the **Delay** bits are set, automatic measurement starts according to the setup selected.

Setting **FIFO mode** bits[7:6], starts FIFO operation according to the mode selected, until it will be switched off by resetting FIFO mode bits.

The **FIFO interrupt threshold** allows to program the number of samples stored before interrupt flag will be raised. If FIFO Interrupt Threshold bits are off, the interrupt flag is never activated.

**AUTOMATIC MODE**

This pressure sensor can be configured to work in automatic mode. The automatic mode is started by setting any delay value in the operation register. The ratio parameters in configuration register allow to balance different conversion frequency for raw pressure and temperature.

Example:

Delay = 1 sec, P\_CONF\_REG\_ratio = 1, T\_CONF\_REG\_ratio = 4; yields in starting one pressure conversion every second for one temperature conversion every 4 seconds. In case of the FIFO mode selected, the latest temperature converted is always copied to store a pair of measurements in the FIFO.

FIFO: (p0, T0), (p1, T0), (p2, T0), (p3, T0), (p4, T4), (p5, T4), (p6, T4), (p7, T4), (p8, T8), ...

In the special case where in the automatic mode both ratios were bigger than one like for example P\_CONF\_REG\_ratio = 2 and T\_CONF\_REG\_ratio = 4 every second conversion is not done. The FIFO content will look like:

FIFO: (p0, T0), (p2, T0), (p4, T4), (p6, T4), (p8, T8), (p10, T8), (p12, T12), (p14, T12), (p16, T16), ...

In the phase where the timer triggers an event, but no conversion is scheduled due to all ratios >=2, MCLK will turn on for handling the state machine and SDO will show a short busy state.

**FILTER**

MS5849 has built-in filter selectable from off (mode without filter) to 32 (maximum filtering). It calculates a moving average based on the filter coefficient.

$$y_{\text{mean}} = y_{n-1} - y_{n-1}/k + y_n/k$$

Once the filter is switched on, the next conversion result of the ADC is used as start value. To restart the filter, it needs to be switched off and on again.

The settling time for a quick impulse change to reach **90% of the final value is 2.2 \* k samples**. The rms noise is reduced by a factor of:

Filter	Noise reduction factor
off	1.00 +/- 0.00
2	1.73 +/- 0.07
4	2.65 +/- 0.21
8	3.87 +/- 0.50
16	5.54 +/- 1.00
32	7.80 +/- 2.00

**Table 4:** Filter noise reduction.

## FIFO OPERATION

The FIFO registers can store 32 pairs of temperature and pressure data. Reading is done as first in and first out.

There is two operating modes, configured by setting the operation register bits[7:6]. See [Operation Register section](#) for additional information.

- FIFO Full mode
- FIFO Update mode

In **Full mode**, the register is filled with all incoming conversions until the 32 pairs are completed.

In **Update mode**, once the register filling is completed, the 1st value stored are replaced by the new converted one, then the 2nd is replaced, and so on indefinitely.

FIFO storage capability may be used either in single conversion mode or in automatic storage mode.

### Read ADC values from FIFO registers

Once a 'Read' command is received, data where Read cursor is pointing at are sent through the communication lines. After the reading procedure whether successful or interrupted, the read cursor position will stay until the next Read command is issued. In other words, the Read cursor is incremented at the beginning of the reading process. This means that, if the current reading is not properly performed, this value is lost, and the next FIFO access will return the following value.

In FIFO **Full mode**, it's possible to store and retrieve 32 values before FIFO register will start to discard newly converted values (see Figure 3).

In **Update mode**, it's only possible to retrieve 31 values. This avoids the Write and the Read cursor addressing the same FIFO value (see Figure 3).

**FIFO threshold** can be selected in the operation register (see [Operation Register section](#) for additional information). It is possible to set a FIFO threshold from 1...31. An interrupt upon FIFO threshold (see [Interrupt section](#) for additional information) will be raised as soon as the FIFO reaches the number of data samples.

For example, if FIFO threshold = 5, the interrupt flag will be raised once Write cursor is 5 data samples ahead of the Read cursor; then 5 data samples may be read.

The **FIFO interrupts** can be set only after conversion finishes. The FIFO storage will not stop once threshold is reached and continues to fill in the 32 positions until it will be full.

### Switch off FIFO mode

The FIFO mode is switched off by setting **FIFO mode** bits[7:6] (see [Operation Register section](#) for additional information.) to off in the operation register. Once done FIFO registers will be emptied and both cursors will be reset.



FIFO OPERATION (CONTINUED)

FIFO combined with automatic mode

As soon as the automatic mode is started, the access to the configuration registers is no more available; therefore the configuration of both p & T should be set as expected, before activating the automatic mode.

In automatic mode when **Ratio** is set for example p\_reg\_ratio = 1, T\_reg\_ratio = 4, a pressure conversion is done every cycle for only a temperature conversion every 4<sup>th</sup> cycle. In this case the latest available temperature is copied to have always pairs of measurements in the FIFO.

Example:

FIFO: (p0, T0), (p1, T0), (p2, T0), (p3, T0), (p4, T4), (p5, T4), (p6, T4), (p7, T4), (p8, T8), ...

In the particular case where in the automatic mode both ratios are different than 1, like for example p\_reg\_ratio = 2 and T\_reg\_ratio = 4, every second conversion is not done. The FIFO content will look like:

FIFO: (p0, T0), (p2, T0), (p4, T4), (p6, T4), (p8, T8), (p10, T8), (p12, T12), (p14, T12), (p16, T16), ...

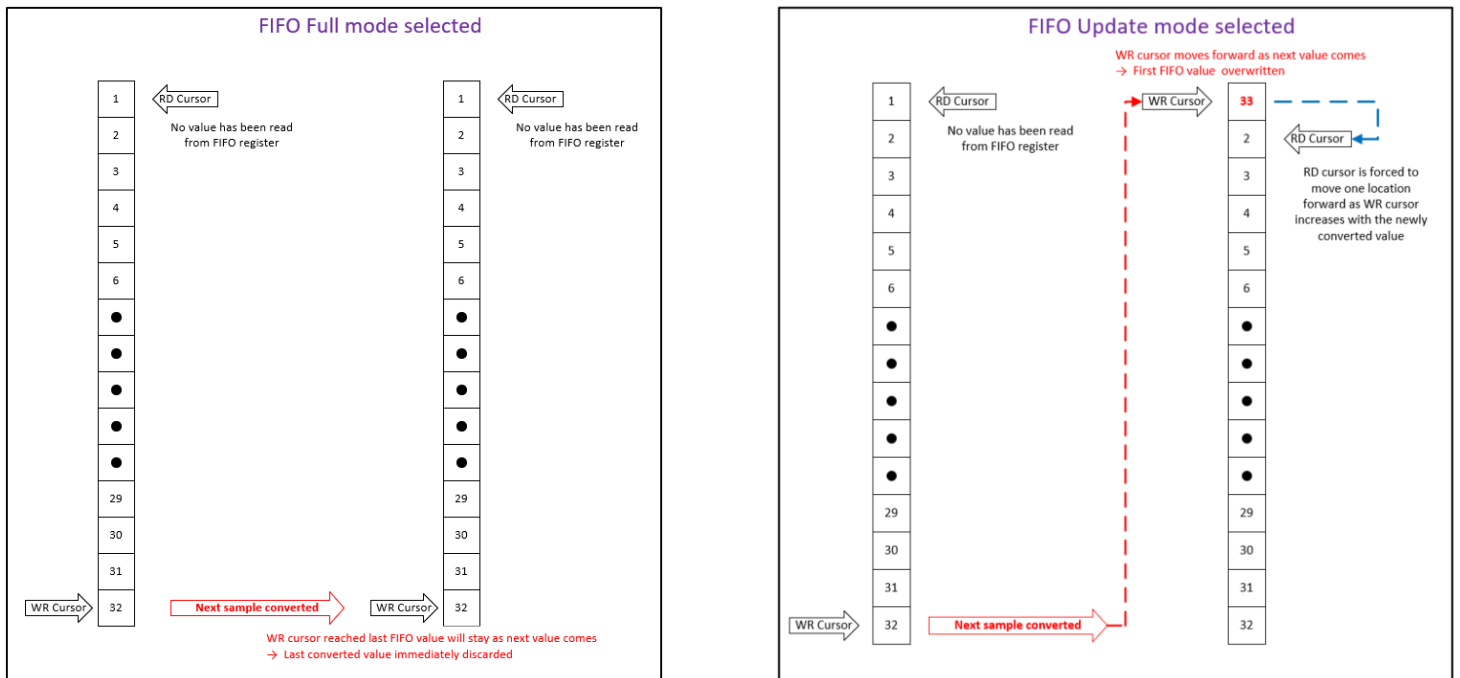

Figure 3: FIFO Modes.

**INTERRUPT**

The MS5849 sensor has the capability to raise an interrupt for some different conditions, listed in Table 6. The external interrupt signal (INT) is only activated if the corresponding enable bit of the interrupt mask is set.

At startup, all enable bits of the interrupt mask are set to 0.

The interrupt register may be read by the user. The interrupt flag must be cleared by the user by writing a one into the corresponding register bit after handling the interrupt.

Name	User Commands							
	7	6	5	4	3	2	1	0
Write Interrupt Mask	CMD	CMD	CMD	CMD/adr	CMD/adr	CMD/adr	CMD/adr	Stop
Write Interrupt Mask	0	0	0	1	1	0	0	x
Read Interrupt Mask	0	0	0	1	1	0	1	x
Write Interrupt Reg	0	0	0	1	1	1	0	x
Read Interrupt Reg	0	0	0	1	1	1	1	x

**Table 5:** Write/Read Interrupt Mask and Register.

Register	7	6	5	4	3	2	1	0
Interrupt	CRC error	p_high	p_low	T_high	T_low	FIFO full	FIFO threshold	ADC done
Mask Enable default	0	0	0	0	0	0	0	0

**Table 6:** Interrupt Register.

- CRC** – CRC check status: 0 = OK, 1 = CRC failed.
- p\_high** – high pressure limit, is set to 1 if the digital pressure conversion output > p\_high.
- p\_low** – low pressure limit, is set to 1 if the digital pressure conversion output < p\_low.
- T\_high** – high temperature limit, is set to 1 if the digital temperature conversion output > T\_high.
- T\_low** – low temperature limit, is set to 1 if the digital temperature conversion output < T\_low.
- FIFO full** – is set to 1 if the FIFO contains 32 unread values.
- FIFO threshold** – is set to 1 if the FIFO contains n unread values (n is set in the operation register).
- ADC done** – is set to 1 if the ADC conversion has finished.
- Mask Enable** – enables the corresponding interrupt: 0 = interrupt not seen at INT, 1 = interrupt seen at INT.

Writing ‘0000 0101’ into the interrupt register will clear the “FIFO full” and “ADC done” interrupts leaving the others untouched.

All interrupts will flag immediately when they appear. For instance, a T and p conversion is requested. Right after the T is gotten, the T\_high and T\_low limits are updated in the interrupt register and the interrupt output signal INT

is raised in case it is enabled, even if the p conversion is pending. Reading T and p after a T\_low or T\_high interrupt will give the actual T but the previous p in case the pressure conversion has not finished yet.

This is also the case of the “ADC done”. For instance, a T and p conversion is requested. Right after the T is available, the “ADC done” flag is set and the interrupt output signal INT is raised if the “ADC done” mask is 1, even if the p conversion is pending. Be careful, after the first interrupt, reading the T and p will result in the latest T value and the previous p value.

The sequence looks like:

T1, p1 available -> run T and p -> start T -> ADC done raised -> T2, p1 available -> start p -> ADC done raised again (if cleared in between) -> T2, p2 available.

**LIMIT REGISTERS FOR RAW PRESSURE AND TEMPERATURE**

The limit register may be used to program low and high threshold values for the pressure and temperature raw data. If ADC results are outside these limits, the according flag in the interrupt register will be set, and if the mask is activated, an interrupt will be raised at the INT pin. At startup, the limits are set to 0000h for the low limits and FFFFh for the high limits. The limits stored in D[15:0] are compared with the 16 MSB’s of the ADC results after filtering (if the filter is on).

The comparison is only done at the end of conversion with the limit value already available.

In case of the limit is updated after a finished conversion, comparison is not performed again. Also, in automatic mode if Ratio > 1, comparison is only done once.

Name	User Commands							
	7	6	5	4	3	2	1	0
	CMD	CMD	CMD	CMD/adr	CMD/adr	CMD/adr	CMD/adr	Stop
Write Limits	0	0	1	1	0	adr1	adr0	x
Read Limits	0	0	1	1	1	adr1	adr0	x

Addr	Limit Registers	D[15:0] (Default)
00	T_low	0000h
01	T_high	FFFFh
10	p_low	0000h
11	p_high	FFFFh

**Table 7:** Write/Read Limit Register Command.

**SERIAL INTERFACES**

**COMMAND STRUCTURE**

The MS5849 can be operated with the following commands:

Name	User Commands							
	7	6	5	4	3	2	1	0
Reset	CMD	CMD	CMD	CMD/adr	CMD/adr	CMD/adr	CMD/adr	Stop
Reset	0	0	0	1	0	0	0	x
Write configuration	0	0	1	0	0	0	0 = p	x
Read configuration	0	0	1	0	1	0	1 = T	x
Read memory	1	1	1	adr3	adr2	adr1	adr0	x
Start conversion	0	1	0	0	T	P	x	x
Read ADC register	0	1	0	1	T	P	x	x
Write operation register	0	0	0	1	0	1	0	x
Read operation register	0	0	0	1	0	1	1	x
Write interrupt mask	0	0	0	1	1	0	0	x
Read interrupt mask	0	0	0	1	1	0	1	x
Write interrupt register	0	0	0	1	1	1	0	x
Read interrupt register	0	0	0	1	1	1	1	x
Write limit register	0	0	1	1	0	0 = T	0 = low lim	x
Read limit register	0	0	1	1	1	1 = p	1 = high lim	x

**Table 8:** User commands table

Size of each command is 1 byte (8 bits) as described in the Table 8 above.  
 ADC read command will return 24 bits with the requested finished conversion.  
 Same commands are used in both SPI and I<sup>2</sup>C modes.

### SPI INTERFACE

The serial interface is a 4-wire SPI bus, operating as a slave. CSB (chip select bar), SCL (serial clock), SDA (serial data in), and SDO (serial data out) are used to interact with the SPI master. Communication with the chip starts when CSB is pulled to low and ends when CSB is pulled to high. SCL is controlled by the SPI master and idles low (SCL low on CSB transitions, mode 0). A mode where the clock alternatively idles high is also supported (mode 3).

As detailed in the following chapters, SDO is usually going low when a correct command is accepted and going high again when the chip is idle. If the chip is busy (SDO = low) and another command is sent, SDO stays low and is not able to indicate the command acceptance.

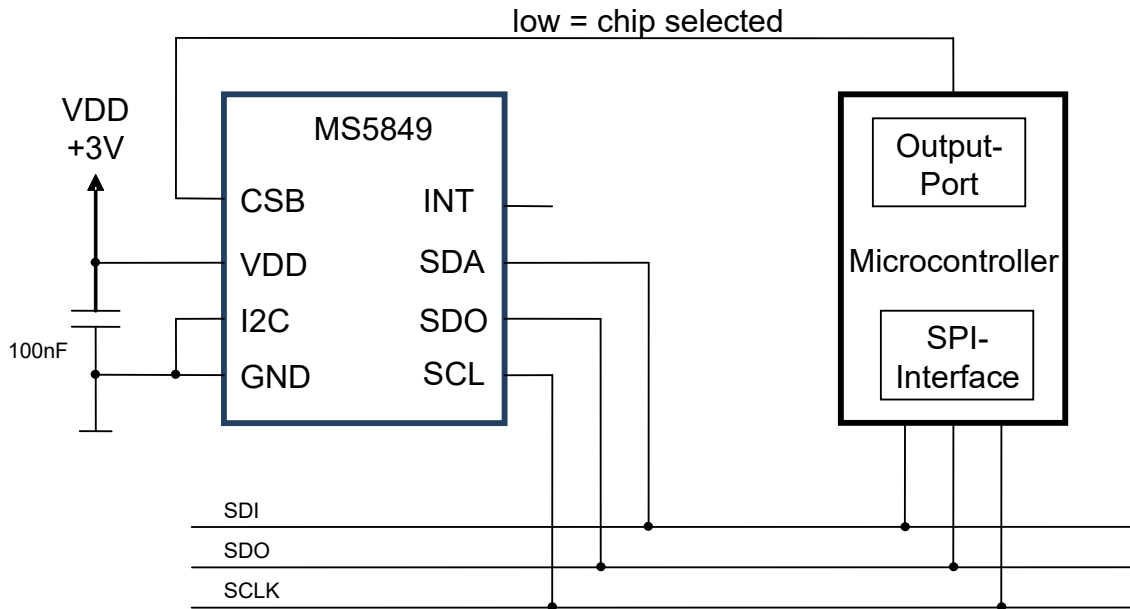
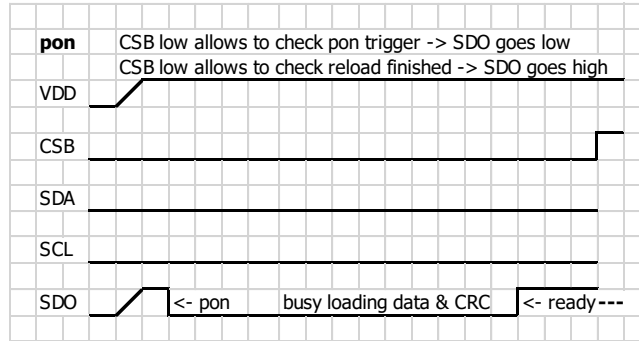

**Figure 4:** SPI protocol application circuit.

**SPI INTERFACE (CONTINUED)**

**POWER ON BEHAVIOR**

MS5849 includes an internal power on circuit, which triggers when VDD has reached the operating level. Once the level reached, an internal procedure load and check the data from the NVM. User application must wait until this process finishes before any command is allowed. Keeping CSB low allows to check when the startup has been completed. It's not mandatory to keep CSB low during startup. Loading time is in the range of 70 to 300 µs.



**Figure 5:** Power on behavior.

**RESET**

The reset sequence shall be sent once after power-on to make sure that the calibration data gets loaded into the internal register. It can be also used to reset the device from an unknown condition.

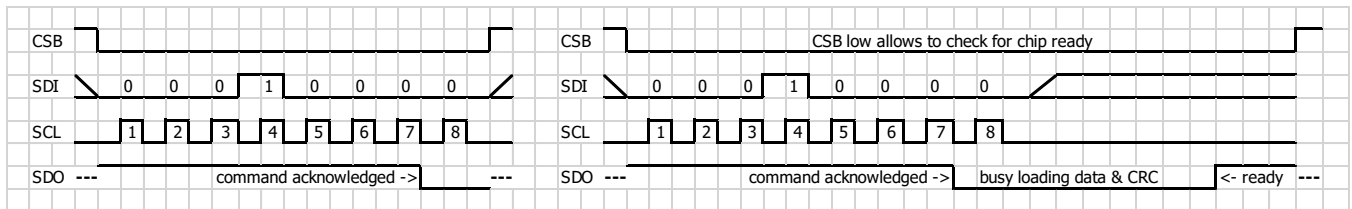

**Figure 6:** Reset using SPI mode 0.

SDO going low indicates the command has been acknowledged. Keeping CSB low allows to check on SDO going high when the reset procedure finished, and the sensor is ready for operation. Loading time is depending on the setup of the CRC and reload bit and is in the range of 70 to 300 µs.

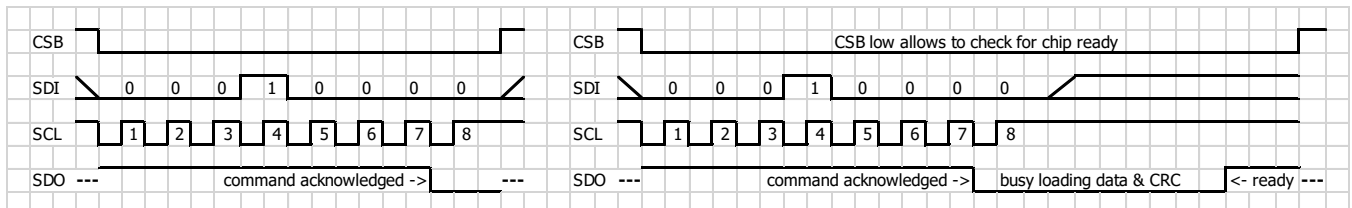

**Figure 7:** Reset using SPI mode 3.

**SPI INTERFACE (CONTINUED)**

**WRITE CONFIGURATION**

Write configuration command allows to configure the ratio, filter, read resolution and OSR of each measurement type separately.

This command is not accepted during an ongoing conversion.

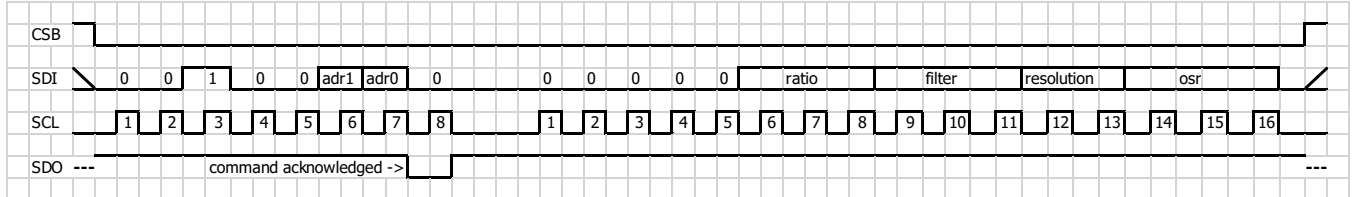

**Figure 8:** Write configuration using SPI mode 0.

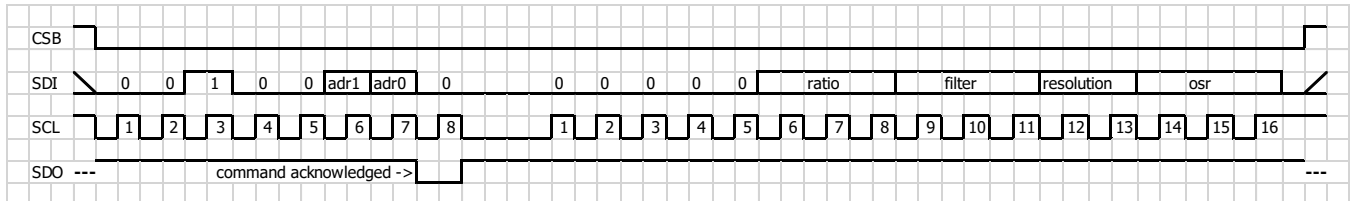

**Figure 9:** Write configuration Register using SPI mode 3.

**READ CONFIGURATION**

Read configuration command allows to verify the programmed configuration.

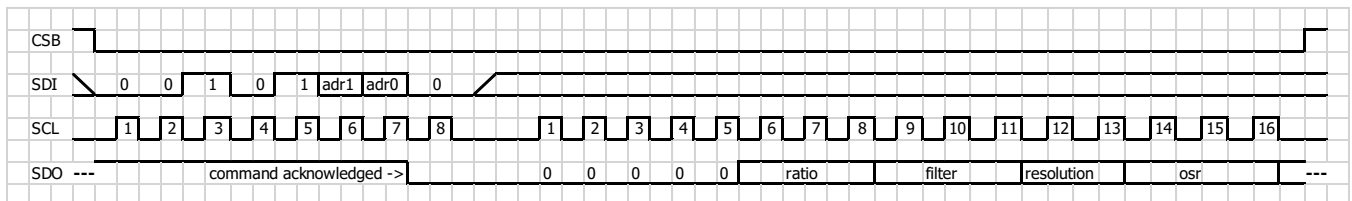

**Figure 10:** Read configuration using SPI mode 0.

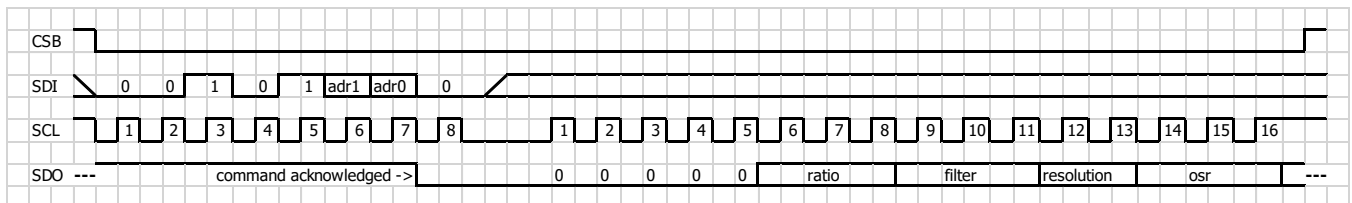
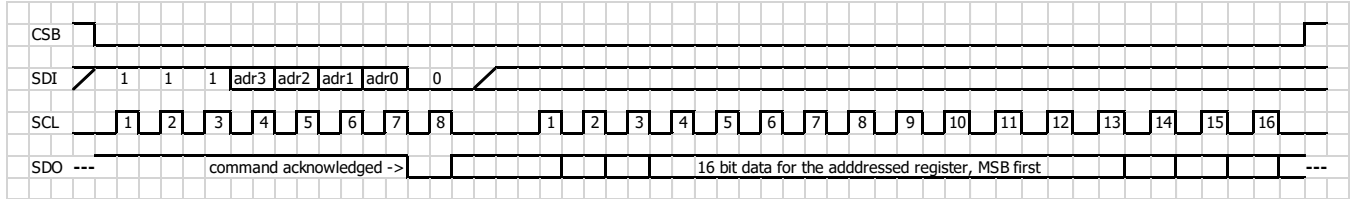

**Figure 11:** Read configuration using SPI mode 3.

**SPI INTERFACE (CONTINUED)**

**READ MEMORY**

Read memory command is used to download coefficients programmed in the memory during factory calibration. These values need to be used in the pressure and temperature algorithm to calculate the compensated measurements.



**Figure 12:** Read memory using SPI mode 0.

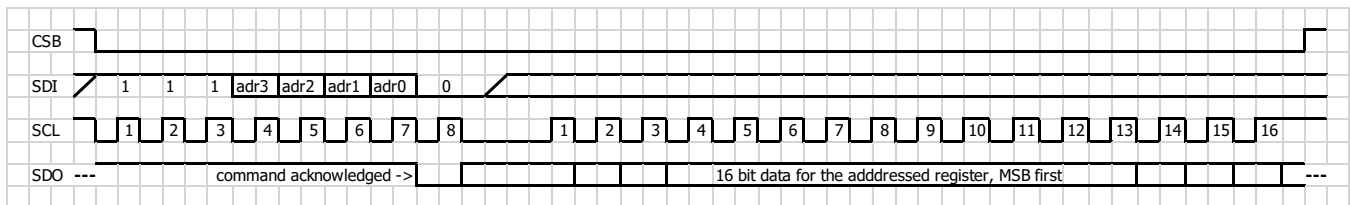
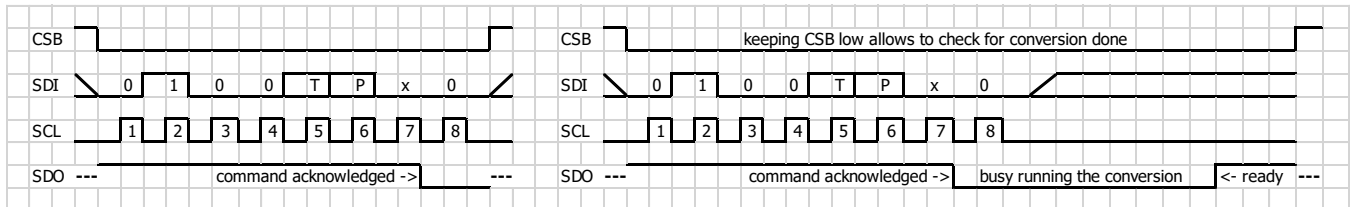

**Figure 13:** Read memory using SPI mode 3.

**START CONVERSION**

Pressure or temperature conversion is started by sending conversion command. If the command is recognized by the pressure sensor, SDO goes low during the time needed to convert the analogic signal. SDO goes high again once conversion is completed. Conversion time depends on the bits P & T selected within the command and the OSR selected. After the conversion, result value is transferred to the data register. SDO line may be monitored to get the time when the operation is finished. This command is not accepted during an ongoing conversion.

Once conversion performed, converted data can be accessed by sending a Read command. Conversions are internally done according to the T & P bit's set in a serial order. First value converted is temperature followed by pressure.



**Figure 14:** Start conversion using SPI mode 0.

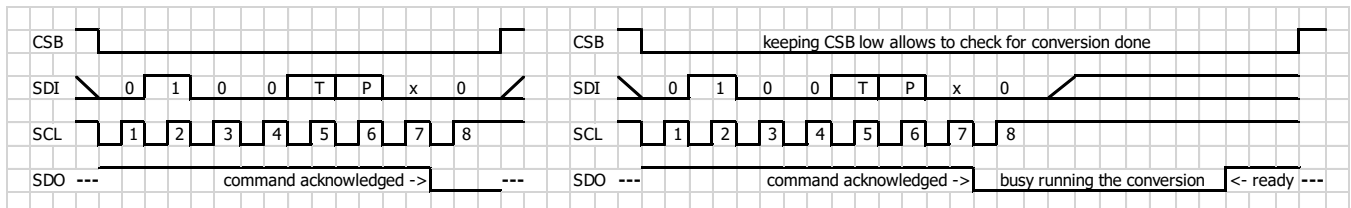

**Figure 15:** Start conversion using SPI mode 3.



**SPI INTERFACE (CONTINUED)**

**READ ADC REGISTER**

Once conversion performed, Read ADC register command allow to transfer converted pressure and temperature value to the application microcontroller. Number of bit's transmitted is fixed according to the configuration register. In FIFO off mode, at startup read ADC without any conversion done will return all one's. After a finished conversion the last converted result will be read. If the FIFO is empty, all one's will be read. Reading can be stopped any time by putting CSB high.

If a temperature and pressure conversion are requested by the conversion command, temperature will be run first and pressure after. Reading when the T has finished, and P is still on going, will yield in reading the latest temperature value, but the previous pressure value in case the pressure conversion is still on going.

This will look like:

T1, p1 available -> run T and p -> start T -> T done -> T2, p1 available -> start p -> p done -> T2, p2 available.

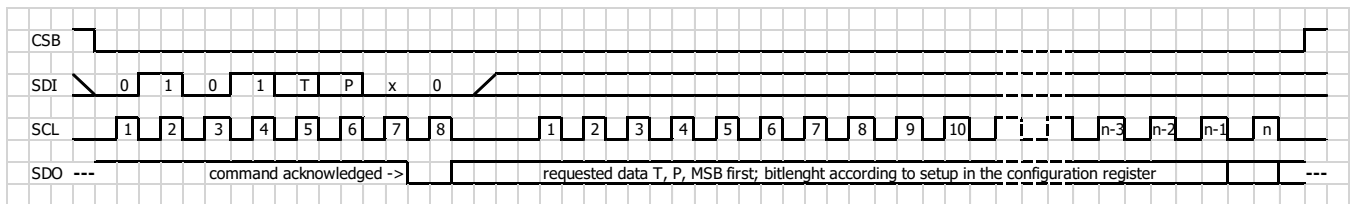

**Figure 16:** Read ADC Register using SPI mode 0.

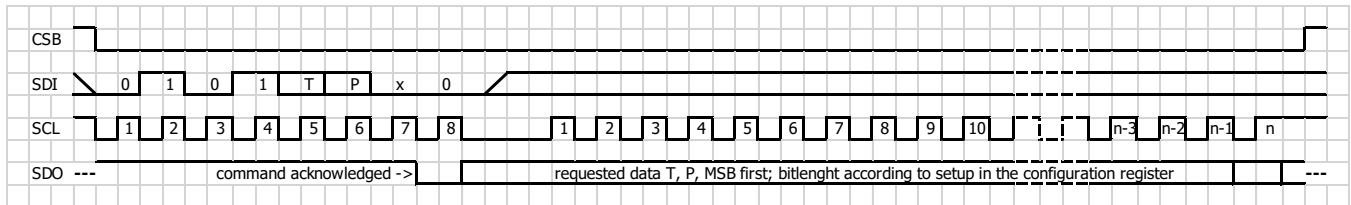
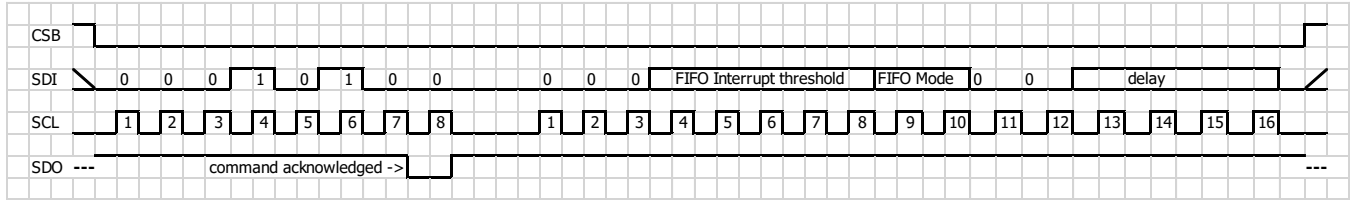

**Figure 17:** Read ADC Register using SPI mode 3.

**SPI INTERFACE (CONTINUED)**

**WRITE OPERATION REGISTER**

With the write operation register command, the behavior of the FIFO and the automatic mode can be controlled.



**Figure 18:** Write operation Register using SPI mode 0.

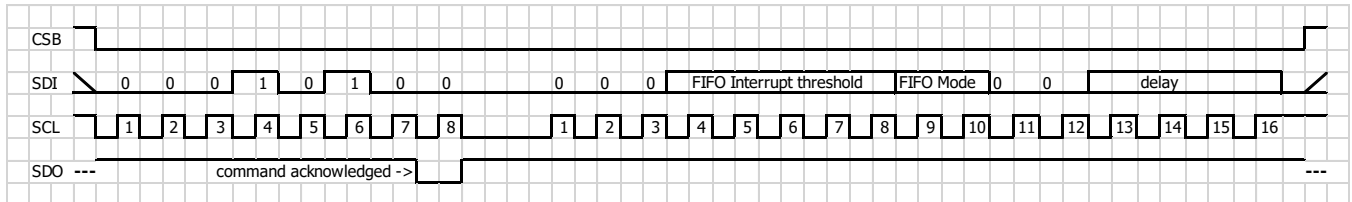

**Figure 19:** Write operation Register using SPI mode 3.

**READ OPERATION REGISTER**

With the read operation register command, the behavior of the FIFO and the automatic mode can be read.

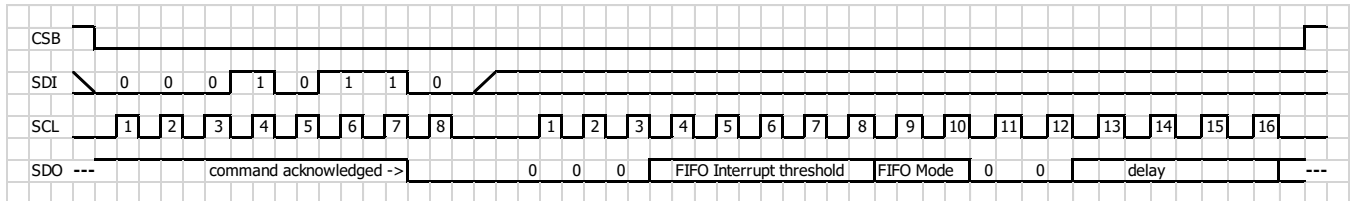

**Figure 20:** Read operation Register using SPI mode 0.

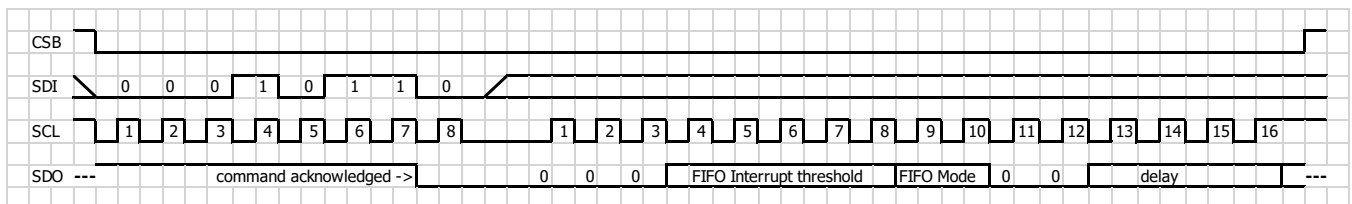
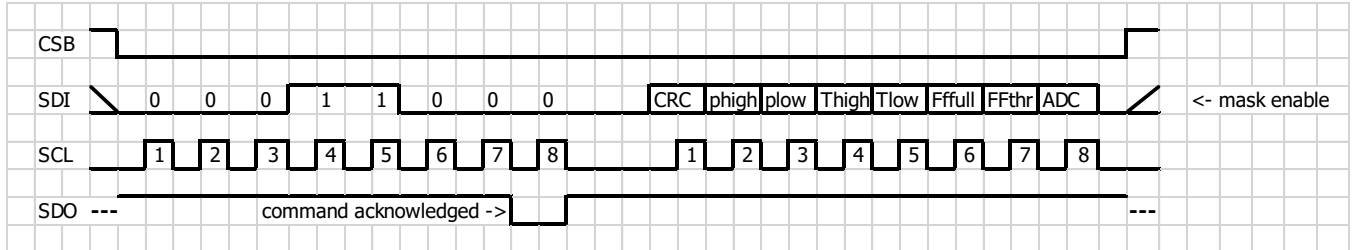

**Figure 21:** Read operation Register using SPI mode 3.

**SPI INTERFACE (CONTINUED)**

**WRITE INTERRUPT MASK**

Write interrupt mask command allow to enable interruptions. Enabled interrupts are routed to the INT output pin which may trigger the user application to execute specific actions.



**Figure 22:** Write interrupt mask using SPI mode 0.

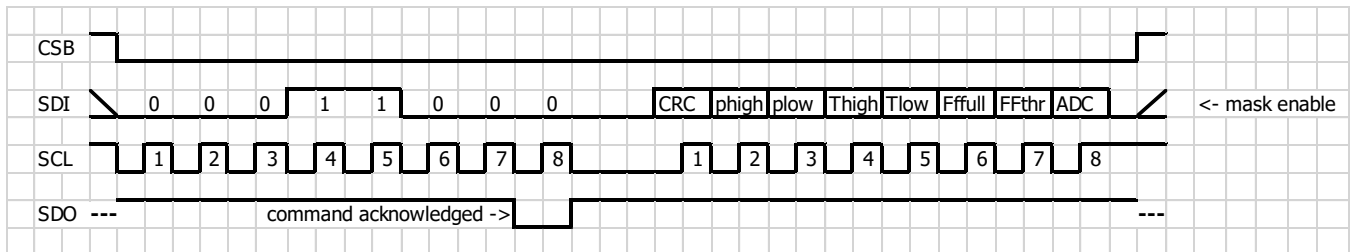

**Figure 23:** Write interrupt mask using SPI mode 3.

**READ INTERRUPT MASK**

Read interrupt mask command allows to read the current configuration data in the interrupt mask register.

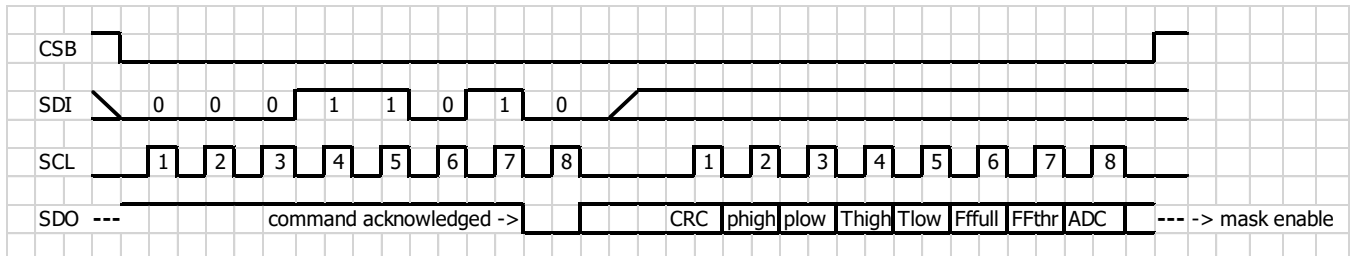

**Figure 24:** Read interrupt mask using SPI mode 0.

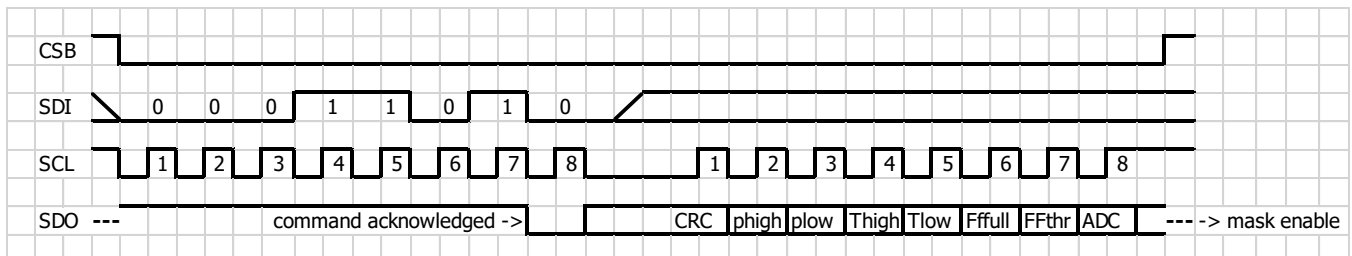
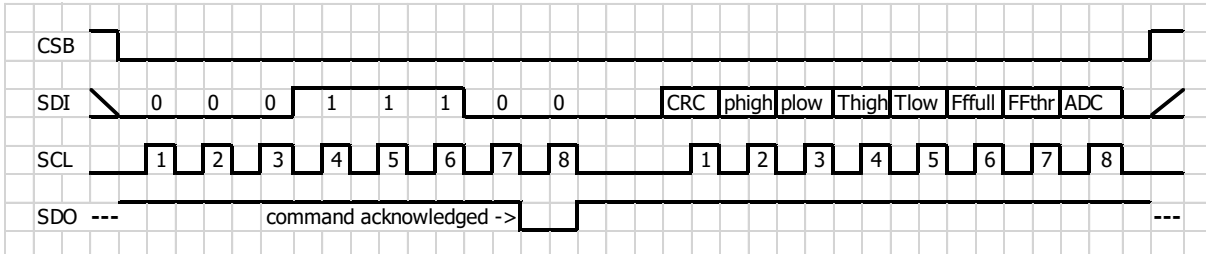

**Figure 25:** Read interrupt mask using SPI mode 3.

**SPI INTERFACE (CONTINUED)**

**WRITE INTERRUPT REGISTER**

Write interrupt register command is used to clear the interrupts by the user application. Interrupts are not cleared automatically while reading the register, they must be cleared by writing a '1' to the desired position in the interrupt register.



**Figure 26:** Write interrupt register using SPI mode 0.

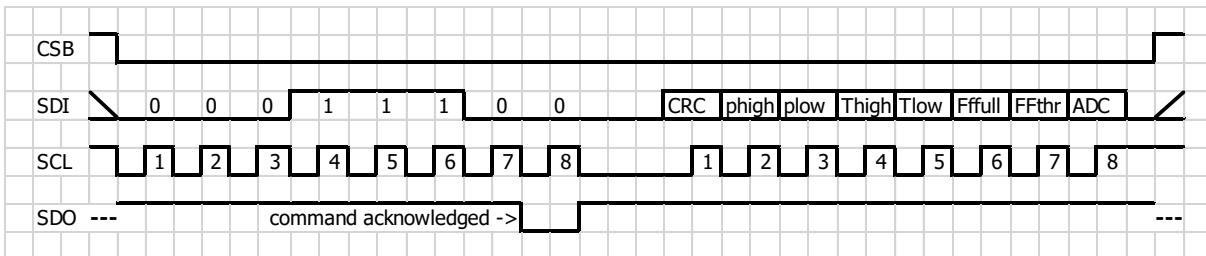

**Figure 27:** Write Interrupt Register using SPI mode 3.

**READ INTERRUPT REGISTER**

Read interrupt register allows the user application to test what was the cause of the interruption raised signal at the INT output pin, or if the interrupt is not enabled to check what action has happened.

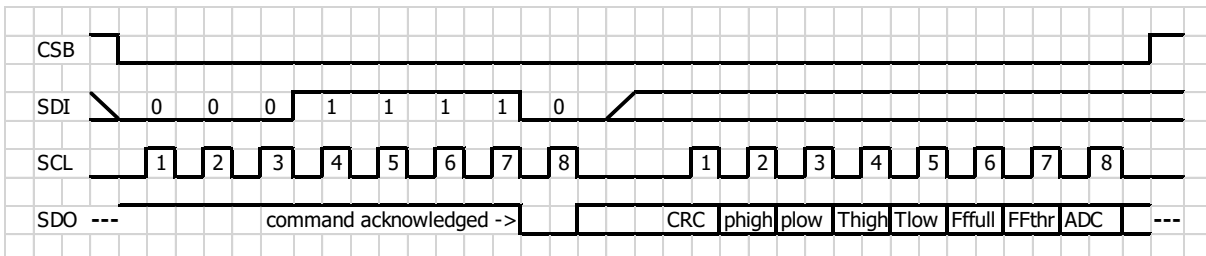

**Figure 28:** Read Interrupt Register using SPI mode 0.

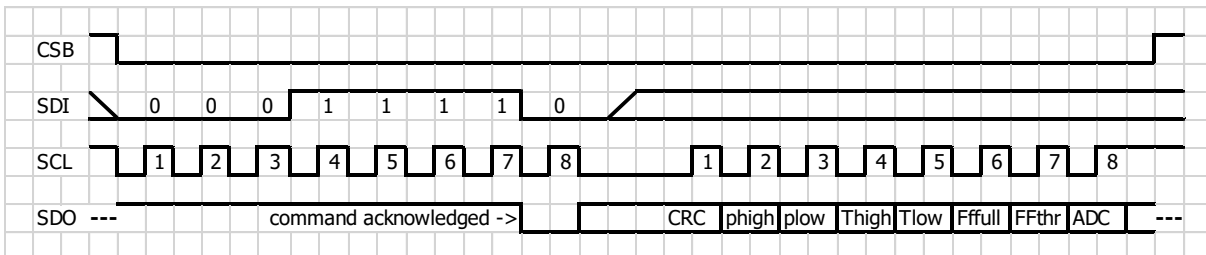
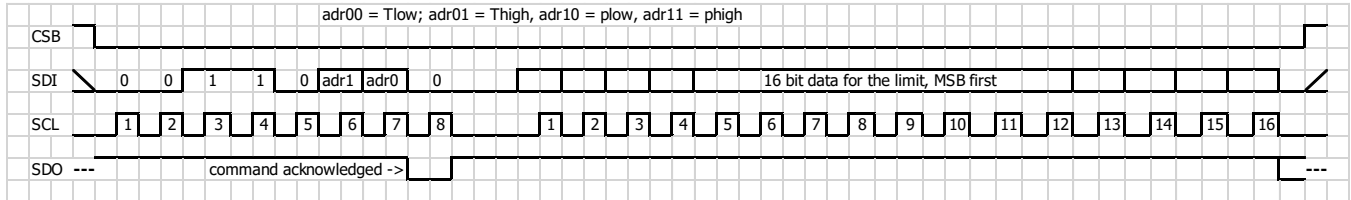

**Figure 29:** Read Interrupt Register using SPI mode 3.

**SPI INTERFACE (CONTINUED)**

**WRITE LIMIT REGISTER**

Write limit register command gives allow to automatically rise an interrupt if one or both converted values does exceed the limits programmed in the registers. Only the 16 MSB's can be programmed and compared to the ADC results.



**Figure 30:** Write Limit Register using SPI mode 0.

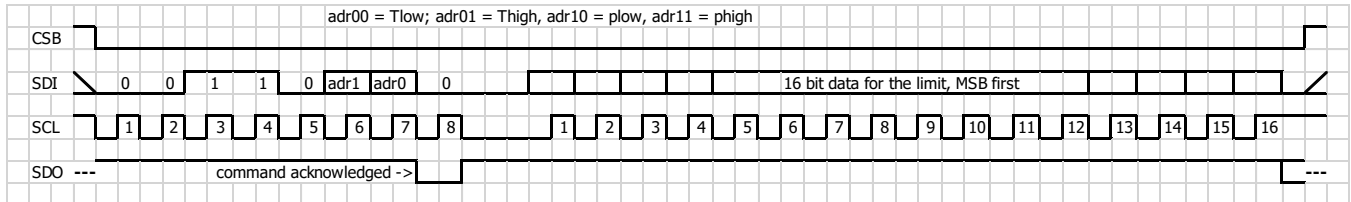

**Figure 31:** Write Limit Register using SPI mode 3.

**READ LIMIT REGISTER**

Read limit register command allows to check programmed set limits.

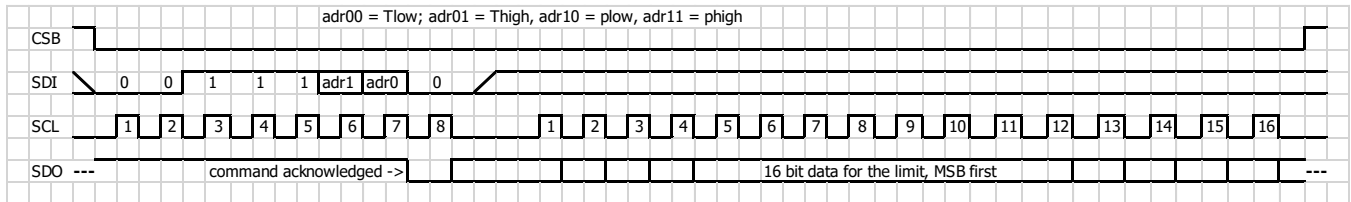

**Figure 32:** Read Limit Register using SPI mode 0.

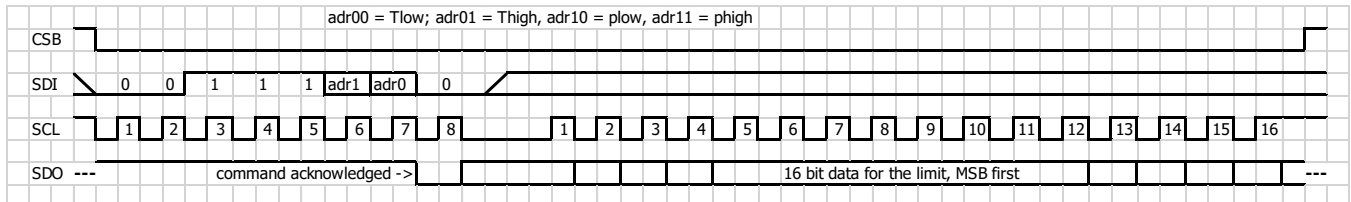

**Figure 33:** Read Limit Register using SPI mode 3.

**I<sup>2</sup>C INTERFACE**

The external microcontroller clocks in the data through the input SCL (Serial CLock) and SDA (Serial DAta). The sensor responds on the same pin SDA which is bidirectional for the I<sup>2</sup>C bus interface. This interface type uses only 2 signal lines and does not require a chip select.

Each I<sup>2</sup>C communication message starts with the start condition, and it is ended with the stop condition. Each command consists of two bytes: the address byte and command byte. The MS5849 address is 1110'11 $\bar{C}$ x. The  $\bar{C}$  in the address is defined with the complement of the value at the input of CSB pin. If CSB=1 then the address will be 1110'110x, while if the CSB=0 then the address will be 1110'111x. This allows, that two MS5849 may operate on the same I<sup>2</sup>C bus. To communicate with this mode, I<sup>2</sup>C pin must be connected to VDD.

Sensor	Mode	Pins used	Address (7 bits)	CSB	I <sup>2</sup> C
MS5849	I <sup>2</sup> C	SDA, SCL, CSB, I2C	0x76 (1110110 b)	1	1
MS5849	I <sup>2</sup> C	SDA, SCL, CSB, I2C	0x77 (1110111 b)	0	1

**Table 9:** I<sup>2</sup>C addresses.

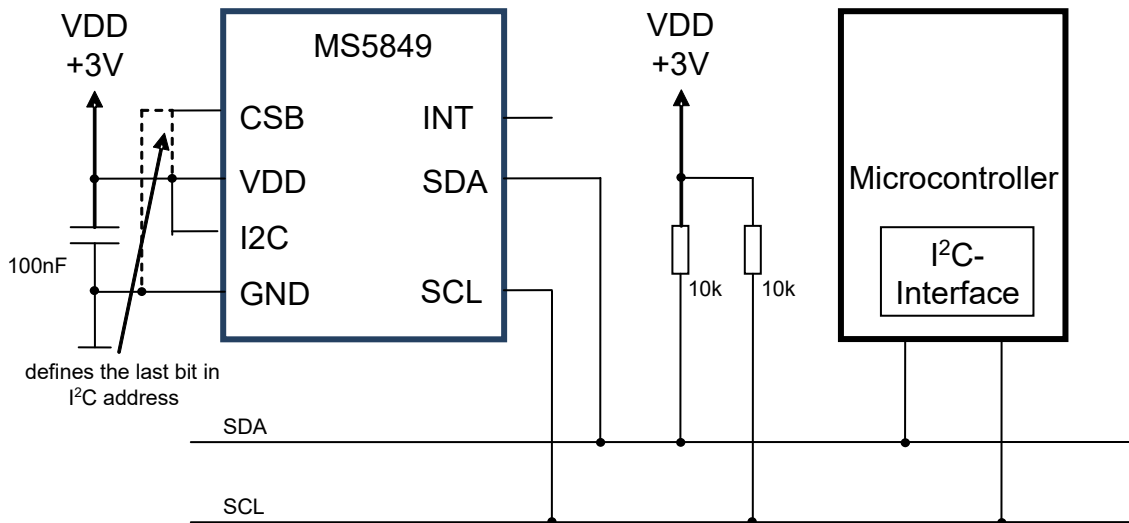

**Figure 34:** Typical I<sup>2</sup>C application circuit

Commands for I<sup>2</sup>C and SPI are similar. Content of command bytes are the same as the SPI one.

SDO output will react the same way as in SPI mode.

**I<sup>2</sup>C INTERFACE (CONTINUED)**

**RESET**

The reset sequence shall be sent once after power-on to make sure that the calibration data gets loaded into the internal register. It can be also used to reset the device from an unknown condition.

The reset can be sent at any time. If power on reset is not a successful, maybe caused by the SDA being blocked by the pressure sensor in the acknowledge state, the only way to get the MS5849 to function is to send several SCLs followed by a reset sequence or to perform a power OFF-ON cycle.

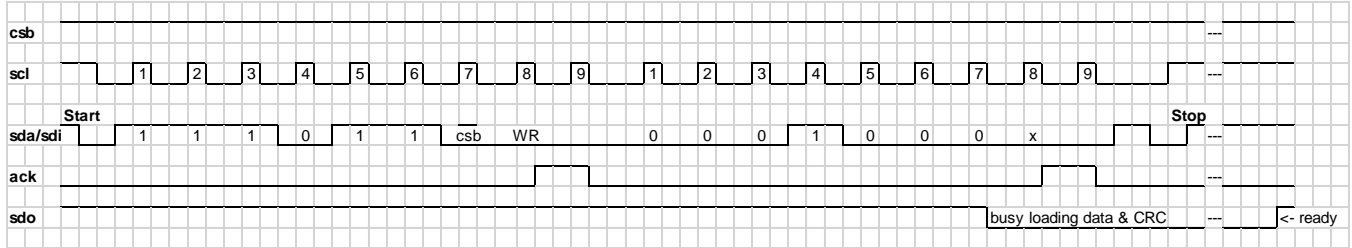
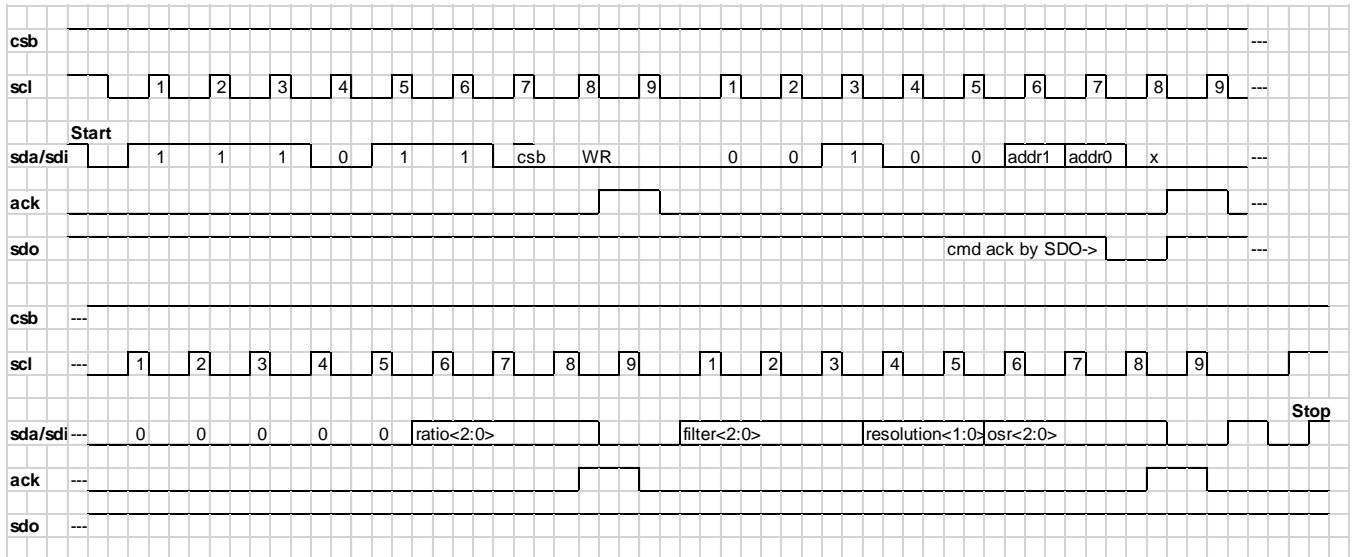

**Figure 35:** Reset using I<sup>2</sup>C.

**WRITE CONFIGURATION**

Write configuration command allows to configure the ratio, filter, read resolution and OSR of each measurement type separately.

This command is not accepted during an ongoing conversion.

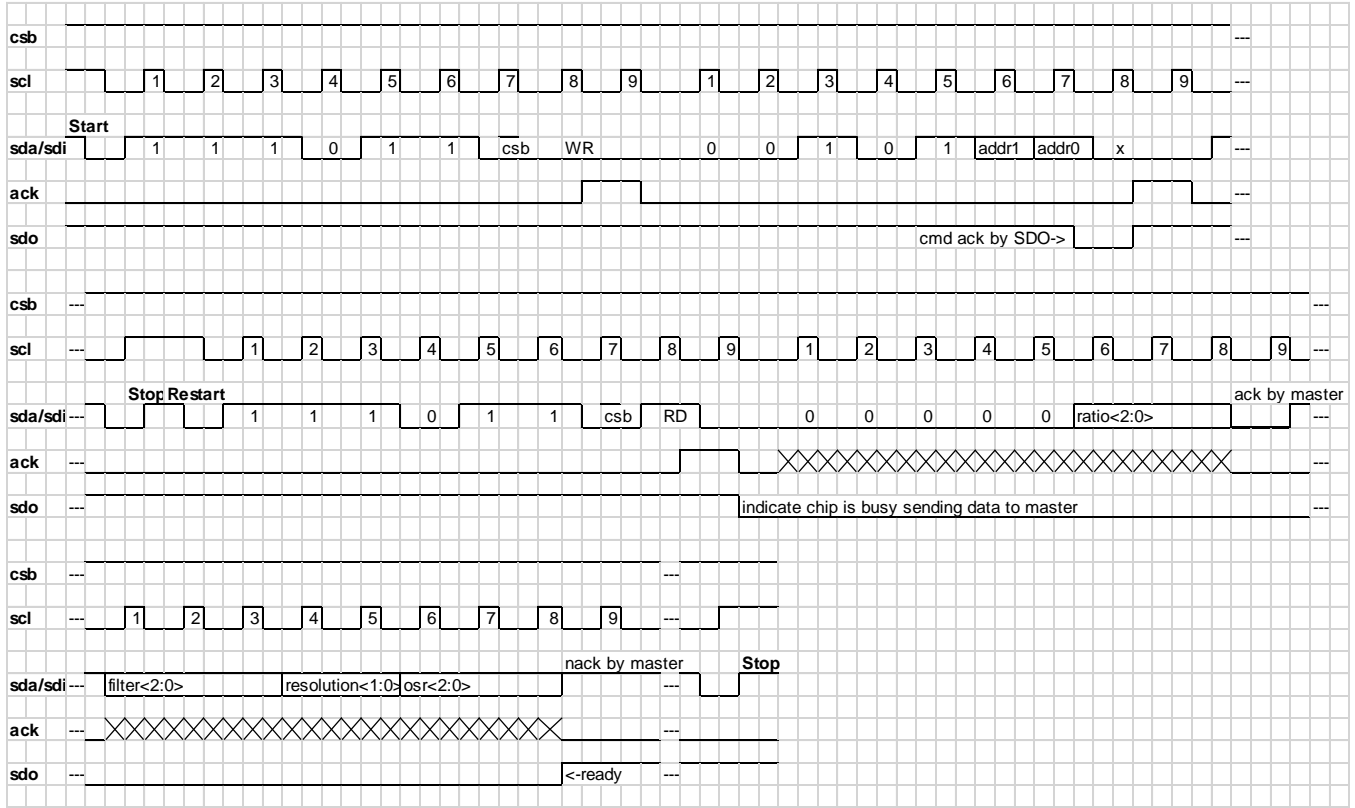

**Figure 36:** Write configuration using I<sup>2</sup>C.

**I<sup>2</sup>C INTERFACE (CONTINUED)**

**READ CONFIGURATION**

Read configuration command allows to verify the programmed configuration.



**Figure 37:** Read configuration using I<sup>2</sup>C.



**I<sup>2</sup>C INTERFACE (CONTINUED)**

**READ MEMORY**

Read memory command is used to download coefficients programmed in the memory during factory calibration. These values need to be used in the pressure and temperature algorithm to calculate the compensated measurements.

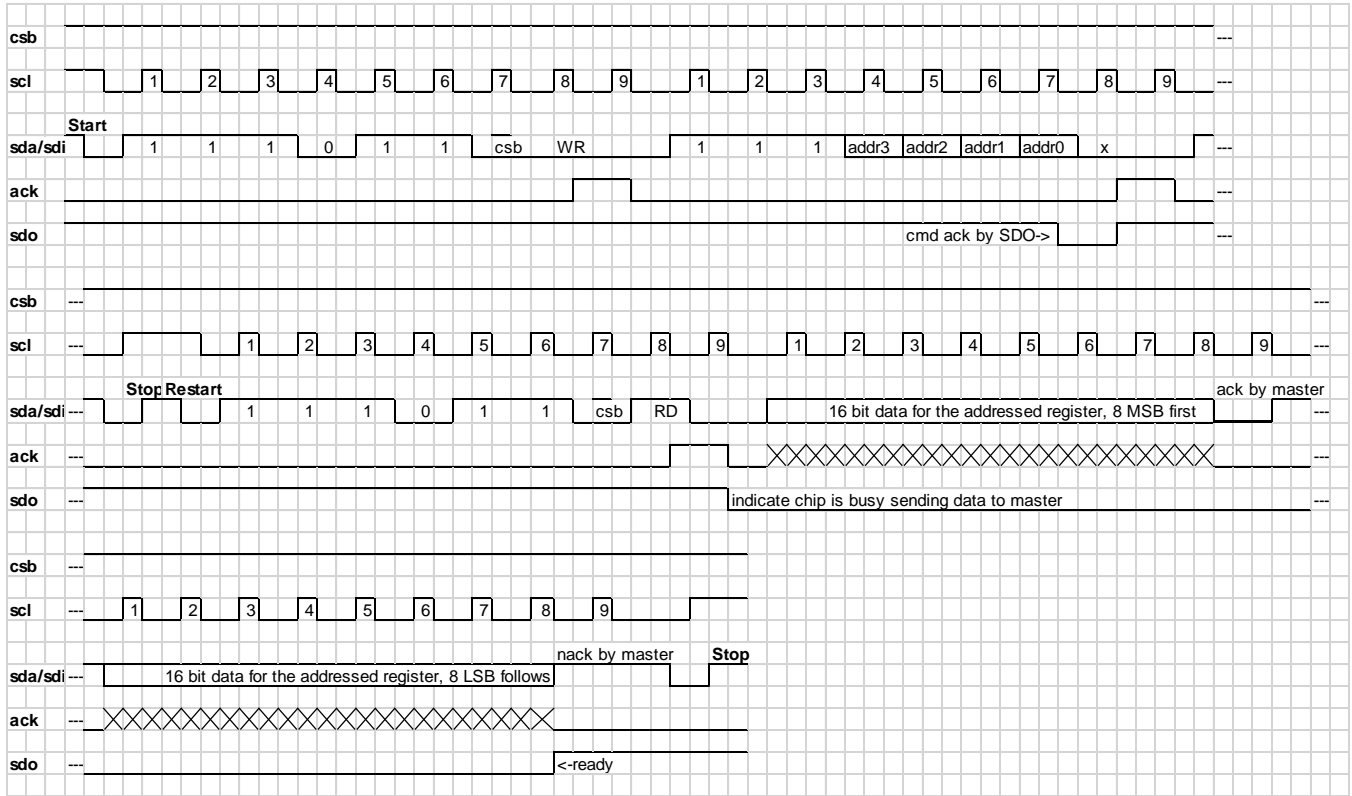

**Figure 38:** Read memory using I<sup>2</sup>C.

**I<sup>2</sup>C INTERFACE (CONTINUED)**

**START CONVERSION**

Pressure or temperature conversion is started by sending Start conversion command. If the command is recognized by the pressure sensor, an ACK is sent to the microcontroller via SDA pin and SDO goes low during the time needed to convert the analogic signal. SDO goes high again once conversion is completed. Conversion time depends on the bits P & T selected within the command and the OSR selected. After the conversion, result value is transferred to the data register. SDO line may be monitored to get the time when the operation is finished. This command is not accepted during an ongoing conversion.

Once conversion performed, converted data can be accessed by sending a Read command. After acknowledge, user microcontroller may start to send 24 SCLK cycles to get all result bits. Every 8 bit the system waits for acknowledge from the master. If the acknowledge is not sent the data clocking out of the chip stops.

Conversions are internally done according to the T & P bit's set in a serial order. First value converted is temperature followed by pressure.

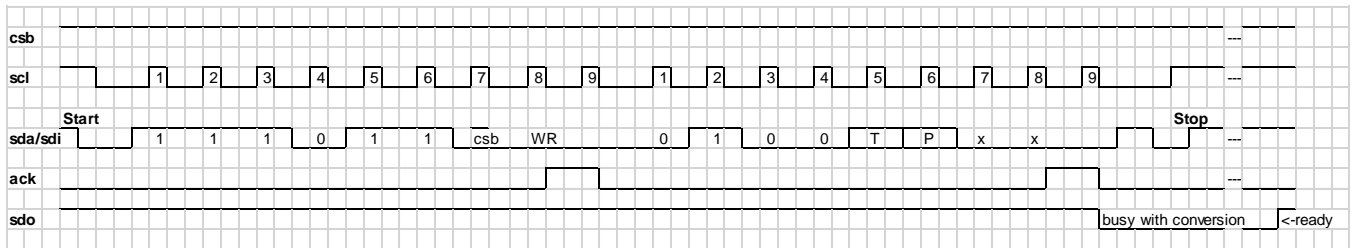

**Figure 39:** Start conversion using I<sup>2</sup>C.

I<sup>2</sup>C INTERFACE (CONTINUED)

READ ADC REGISTER

Once conversion performed, Read ADC register command allow to transfer converted pressure and temperature value to the application microcontroller. Number of bit's transmitted is fixed according to the configuration register. In FIFO off mode, at startup read ADC without any conversion done will return all one's. After a finished conversion the last converted result will be read. If the FIFO is empty, all ones will be read. Reading can be stopped at any time by sending STOP or NACK sequence from the microcontroller.

If a temperature and pressure conversion are requested by the conversion command, temperature will be run first and pressure after. Reading when the T has finished, and p is still on going, will yield in reading the latest temperature value, but the previous pressure value in case the pressure conversion is still on going.

This will look like:

T1, p1 available -> run T and p -> start T -> T done -> T2, p1 available -> start p -> p done -> T2, p2 available.

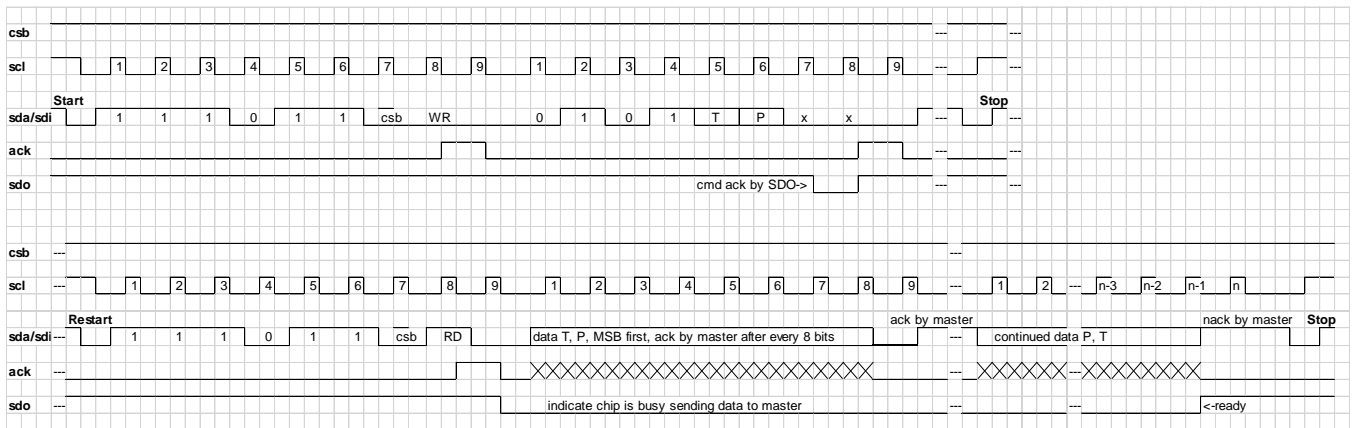

Figure 40: Read ADC Register using I<sup>2</sup>C.

WRITE OPERATION REGISTER

With the write operation register command, the behavior of the FIFO and the automatic mode can be controlled.

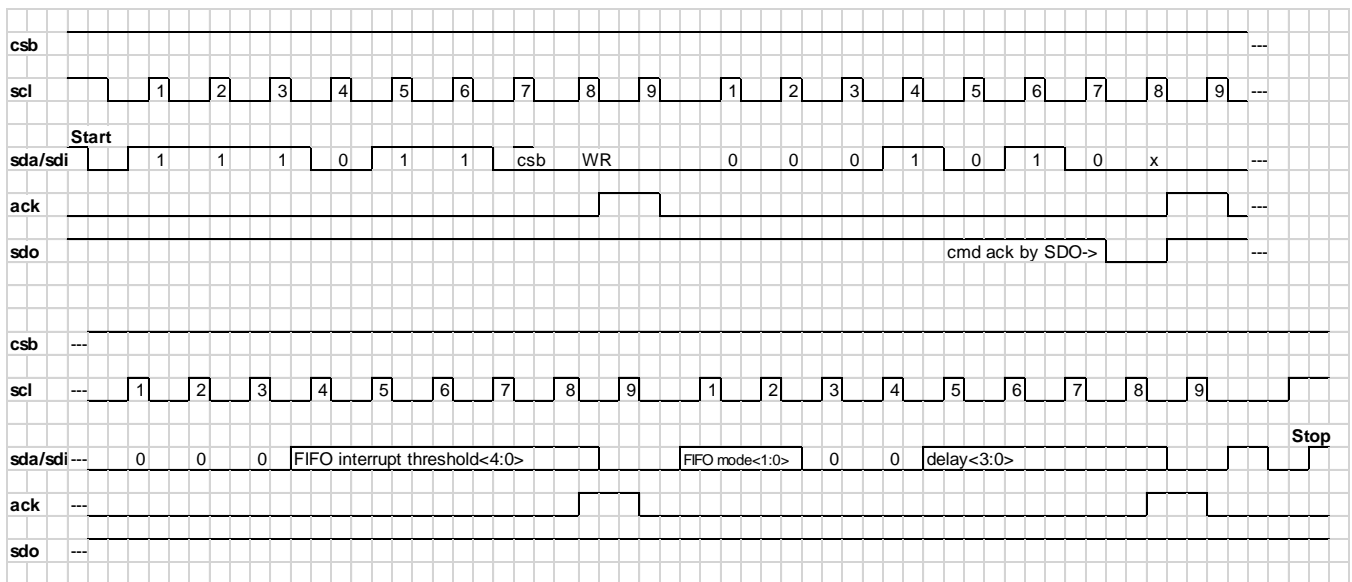
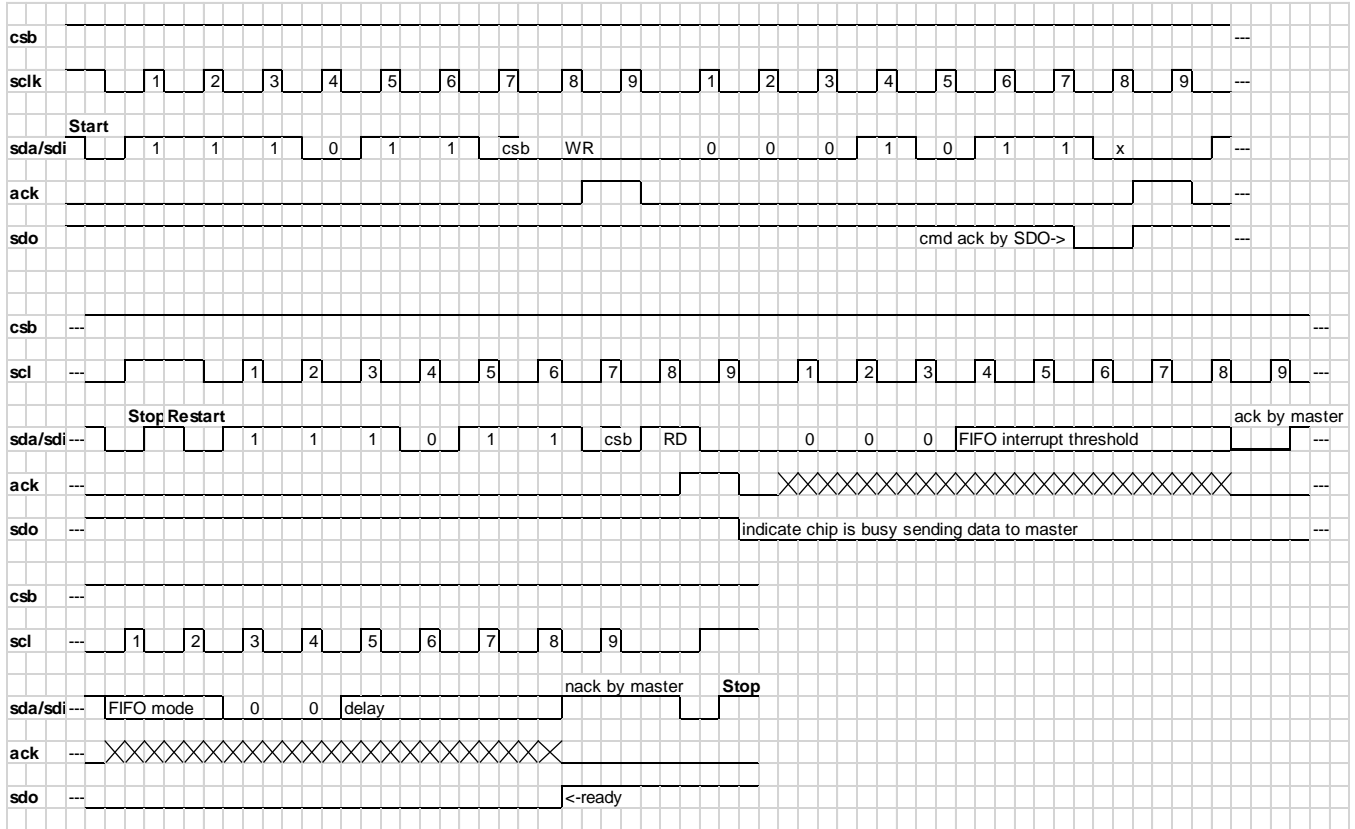

Figure 41: Write Operation Register using I<sup>2</sup>C.

**I<sup>2</sup>C INTERFACE (CONTINUED)**

**READ OPERATION REGISTER**

With the Read operation register command, the current setup can be read.

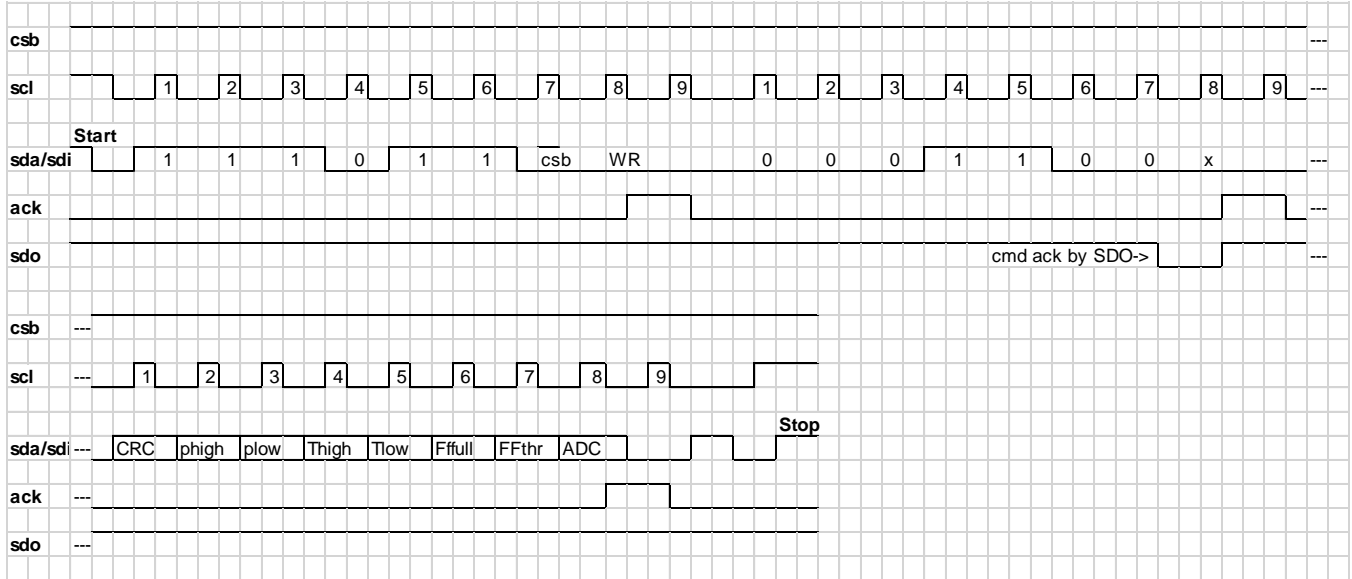

**Figure 42:** Read operation register using I<sup>2</sup>C.

**I<sup>2</sup>C INTERFACE (CONTINUED)**

**WRITE INTERRUPT MASK**

Write interrupt mask command allow to enable interruptions. Enabled interrupts are routed to the INT output pin which may trigger the user application to execute specific actions.



**Figure 43:** Write interrupt mask using I<sup>2</sup>C.

**READ INTERRUPT MASK**

Read interrupt mask command allows to read the current configuration data in the interrupt mask register.

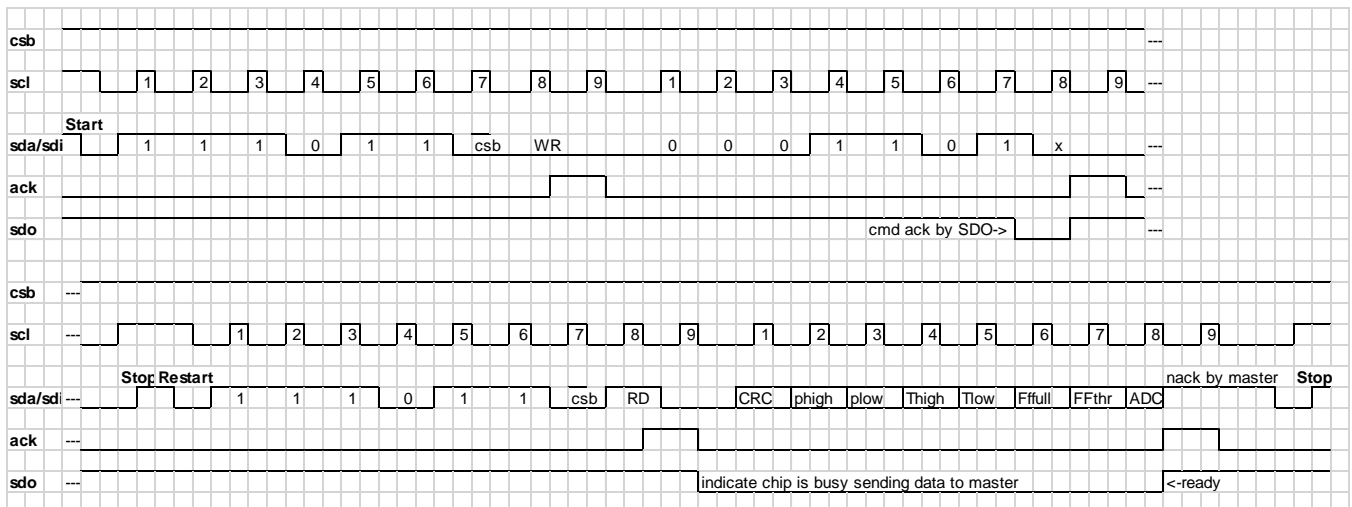
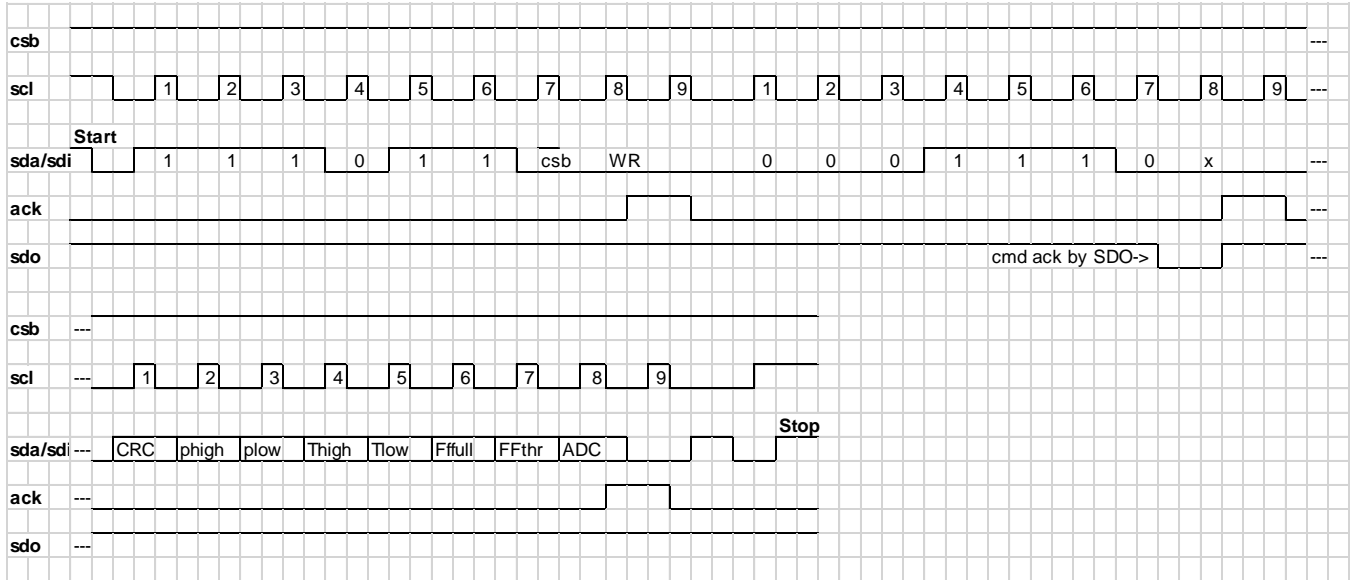

**Figure 44:** Read interrupt mask using I<sup>2</sup>C.

**I<sup>2</sup>C INTERFACE (CONTINUED)**

**WRITE INTERRUPT REGISTER**

Write interrupt register command is used to clear the interrupts by the user application. Interrupts are not cleared automatically while reading the register, they must be cleared by writing a '1' to the desired position in the interrupt register.



**Figure 45:** Write interrupt register using I<sup>2</sup>C.

**READ INTERRUPT REGISTER**

Read interrupt register allows the user application to test what was the cause of the interruption raised signal at the INT output pin, or if the interrupt is not enabled to check what action has happened.

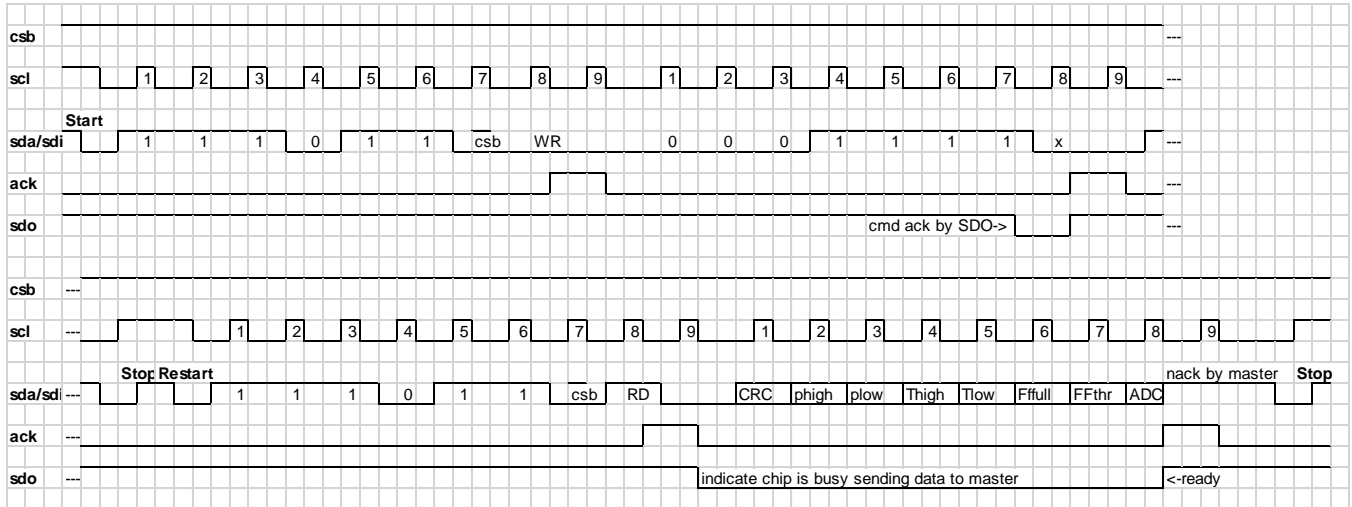
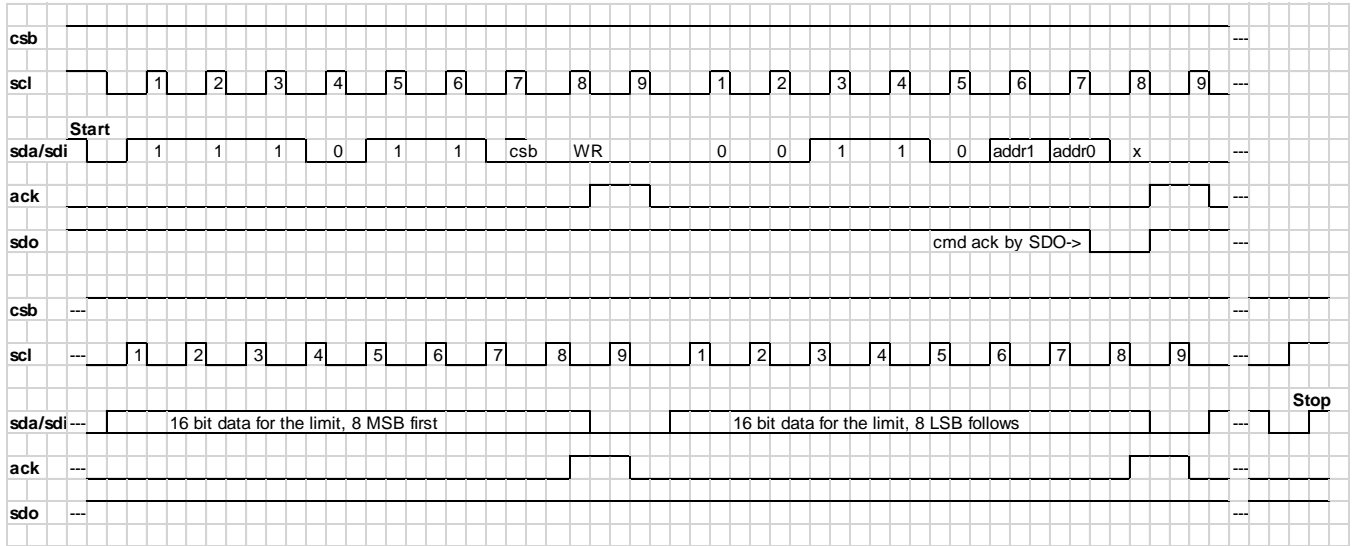

**Figure 46:** Read interrupt register using I<sup>2</sup>C.

**I<sup>2</sup>C INTERFACE (CONTINUED)**

**WRITE LIMIT REGISTER**

Write limit register command gives allow to automatically rise an interrupt if one or both converted values does exceed the limits programmed in the registers. Only the 16 MSB's can be programmed and compared to the ADC results.

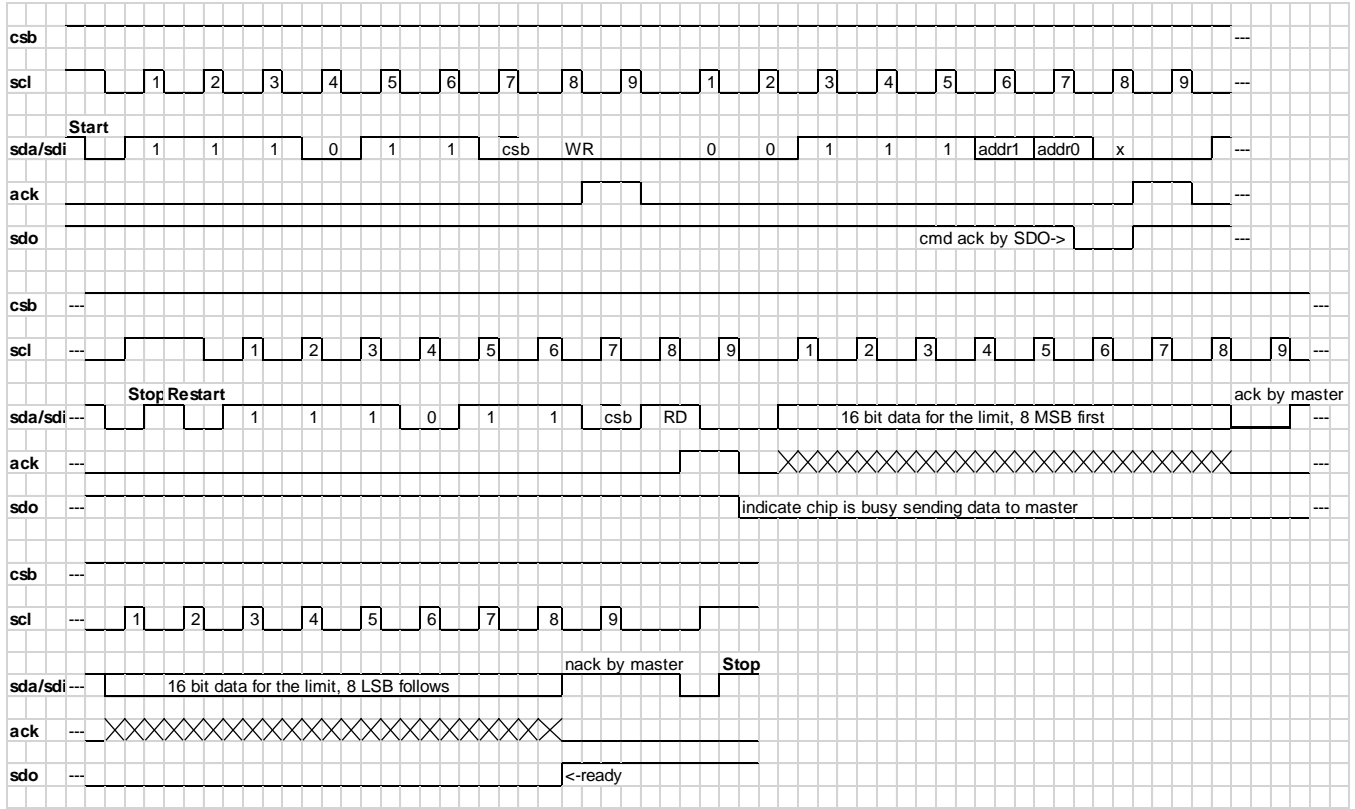

**Figure 47:** Write limit register using I<sup>2</sup>C.

**I<sup>2</sup>C INTERFACE (CONTINUED)**

**READ LIMIT REGISTER**

Read limit register command allows to check programmed set limits.



**Figure 48:** Read limit register using I<sup>2</sup>C.



**CYCLIC REDUNDANCY CHECK (CRC)**

MS5849 contains 256 bits of NVM memory.

CRC is implemented in the digital core to check the integrity of the memory data.

CRC is calculated for each 8-bit of data memory, i.e., one byte of data as the minimum data size over which CRC is executed. For N-byte data, calculation will be done in N steps. This can be illustrated as below.

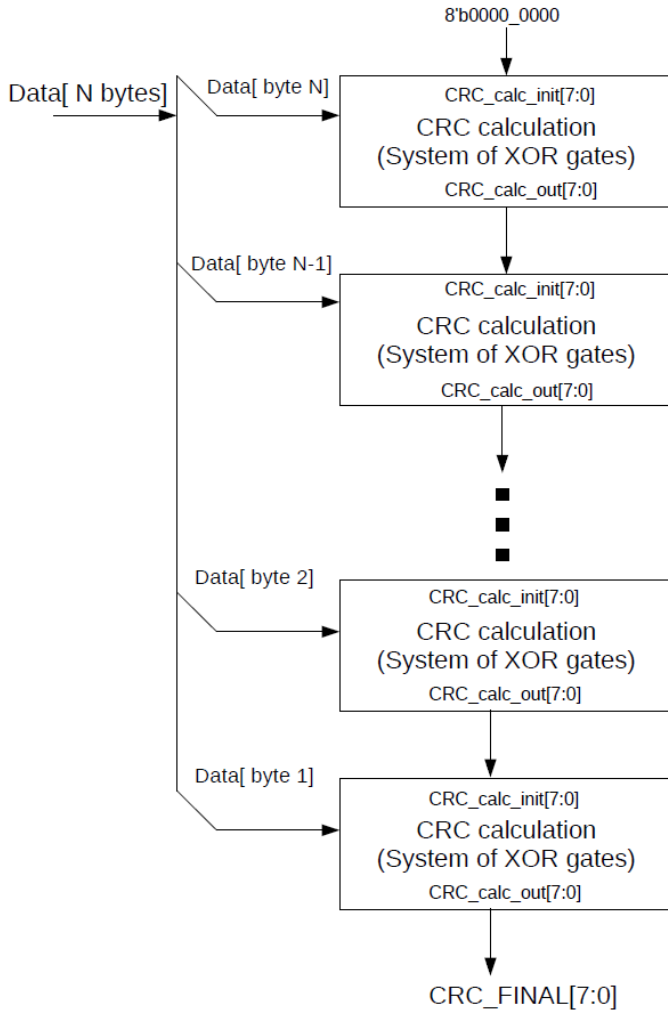

Property	Value
Width	8 bits
Protected data	Read and/or write data
Polynomial	0x31 ( $x^8 + x^5 + x^4 + 1$ )
Initialization	0x00
Reflect input	False
Reflect output	False
Final XOR	0x00
Examples	CRC (0xBEEF) = 0x13

**Figure 49:** Flowchart for CRC calculation.

## CYCLIC REDUNDANCY CHECK (CRC) (CONTINUED)

## 8 BITS CRC CALCULATION FLOW CHART

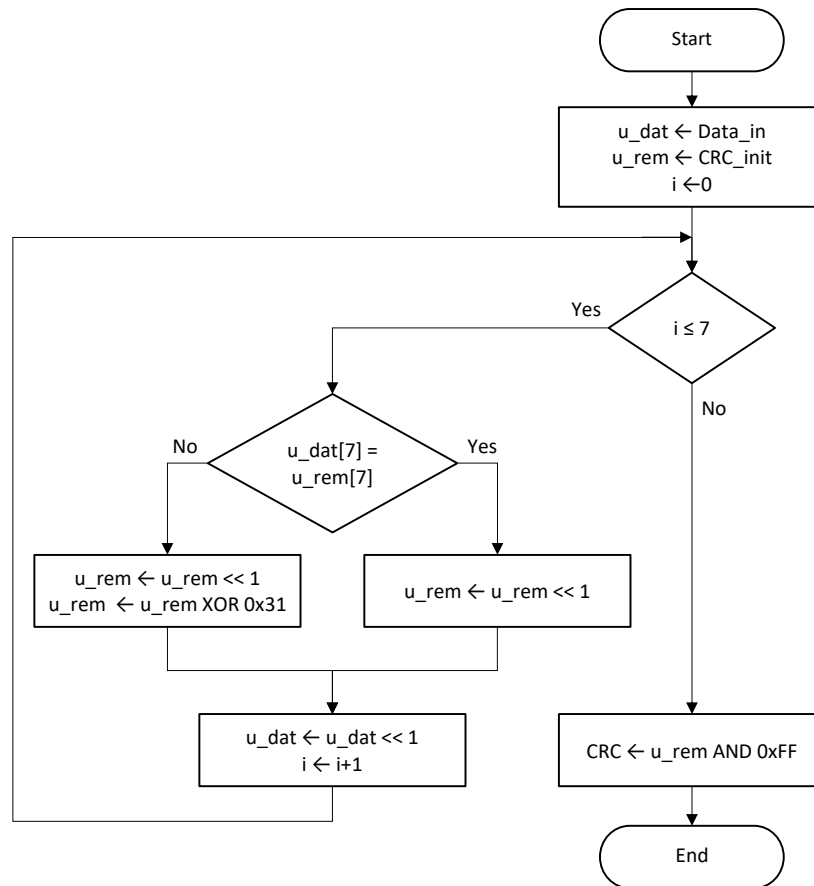

**Figure 50:** CRC8 calculation flowchart & Excel Calculation function.

## Calculation function in C language

```

unsigned char crc_calc(unsigned char Data_in, unsigned char CRC_init)
{
    // Polynom 0x31 = 49 decimal
    int cnt; // counter
    int msb_dat, msb_rem; // most significant bit
    unsigned char u_dat = Data_in; // crc data
    unsigned char u_rem = CRC_init; // crc remainder

    for (cnt = 0; cnt <= 7; cnt++)
    {
        msb_dat = u_dat >> 7;
        msb_rem = u_rem >> 7;
        u_dat = u_dat << 1;
        u_rem = u_rem << 1;
        if (msb_dat != msb_rem) u_rem = u_rem ^ 0x31;
    }
    return (u_rem & 0xFF);
}

```

# MS5849-30BA

Ultra-compact, chlorine resistant, absolute pressure sensor

## CYCLIC REDUNDANCY CHECK (CRC) (CONTINUED)

Example:

Address	Data16	Data8		Data	Rem	CRC
				Init: 0x00		
0	0x00CF	[15:8]	0x00	0x00	0x00	0x00
		[7:0]	0xCF	0xCF	0x00	0x69
1	0x0300	[15:8]	0x03	0x03	0x69	0x60
		[7:0]	0x00	0x00	0x60	0xBB
2	0x0000	[15:8]	0x00	0x00	0xBB	0x55
		[7:0]	0x00	0x00	0x55	0x8B
3	0x0001	[15:8]	0x00	0x00	0x8B	0x90
		[7:0]	0x01	0x01	0x90	0x08
4	0x4513	[15:8]	0x45	0x45	0x08	0x71
		[7:0]	0x13	0x13	0x71	0xD9
5	0x3D08	[15:8]	0x3D	0x3D	0xD9	0x05
		[7:0]	0x08	0x08	0x05	0x4C
6	0x1C1A	[15:8]	0x1C	0x1C	0x4C	0x7E
		[7:0]	0x1A	0x1A	0x7E	0x7F
7	0x3C91	[15:8]	0x3C	0x3C	0x7F	0x6E
		[7:0]	0x91	0x91	0x6E	0xAC
8	0x968A	[15:8]	0x96	0x96	0xAC	0x1E
		[7:0]	0x8A	0x8A	0x1E	0xFD
9	0x4EAD	[15:8]	0x4E	0x4E	0xFD	0xEC
		[7:0]	0xAD	0xAD	0xEC	0x0C
10	0x63D7	[15:8]	0x63	0x63	0x0C	0x95
		[7:0]	0xD7	0xD7	0x95	0x5F
11	0x4EBC	[15:8]	0x4E	0x4E	0x5F	0x72
		[7:0]	0xBC	0xBC	0x72	0x58
12	0x61C3	[15:8]	0x61	0x61	0x58	0x4D
		[7:0]	0xC3	0xC3	0x4D	0x65
13	0x3026	[15:8]	0x30	0x30	0x65	0x8B
		[7:0]	0x26	0x26	0x8B	0xB0
14	0x0000	[15:8]	0x00	0x00	0xB0	0xBF
		[7:0]	0x00	0x00	0xBF	0x91
15	0x0139	[15:8]	0x01	0x01	0x91	0x39
		[7:0]	0x39	0x39	0x39	0x00
<b>CRC</b>						0x00

## MS5849-30BA

Ultra-compact, chlorine resistant, absolute pressure sensor

### PIN CONFIGURATION AND DEVICE PACKAGE OUTLINE

UNLESS OTHERWISE SPECIFIED DIMENSIONS ARE IN MILLIMETERS. GENERAL TOLERANCE  $\pm 0.15$

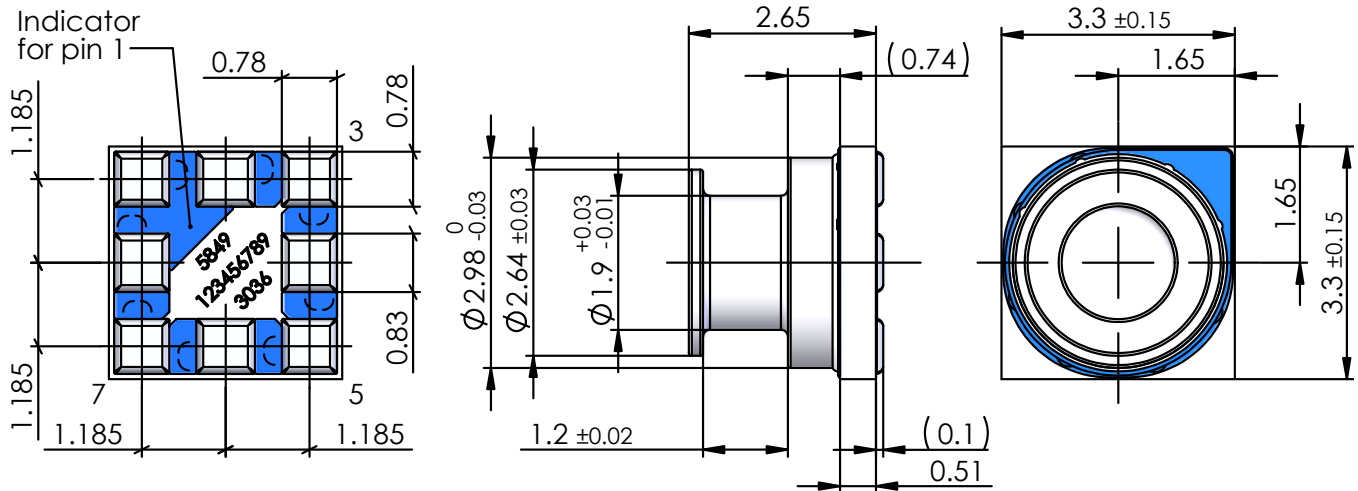

Pin	Name	Type	Function
1	GND	P	GROUND
2	VDD	P	POSITIVE SUPPLY VOLTAGE
3	SCL	I	SPI/I <sup>2</sup> C CLOCK
4	CSB	I	SPI CHIP SELECT
5	INT	O	INTERRUPT
6	SDO	O	SPI DATA OUTPUT
7	SDA	I/O	SPI DATA INPUT / I <sup>2</sup> C DATA
8	I2C	I	PROTOCOL SELECT

Figure 51: Package outline and pin configuration.

### BACK ENGRAVING

On the back of the pressure sensor, the following code is engraved:

Code	Description
5849	Product family
3036	30 is the pressure range in bar. 36 is for shielded and chlorine resistant.
123456789	Manufacturing lot number The prefix "200" must be added, i.e. the full manufacturing lot number is "200" + "123456789"

## MS5849-30BA

Ultra-compact, chlorine resistant, absolute pressure sensor

### WETTED MATERIALS

The wetted materials are the silicone gel and the stainless steel.

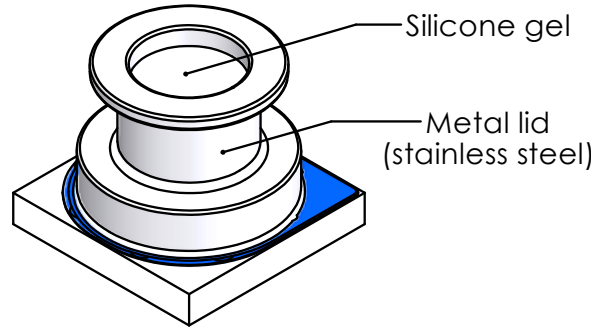

### RECOMMENDED PAD LAYOUT

Pad layout for bottom side of the MS5849-30BA soldered onto printed circuit board.

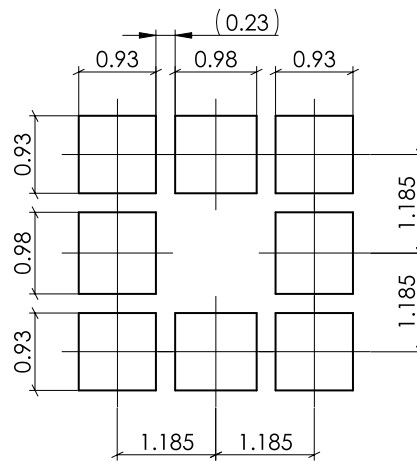

**Figure 52:** Pad layout.

# MS5849-30BA

Ultra-compact, chlorine resistant, absolute pressure sensor

## SHIPPING PACKAGE

### TAPE INFORMATION

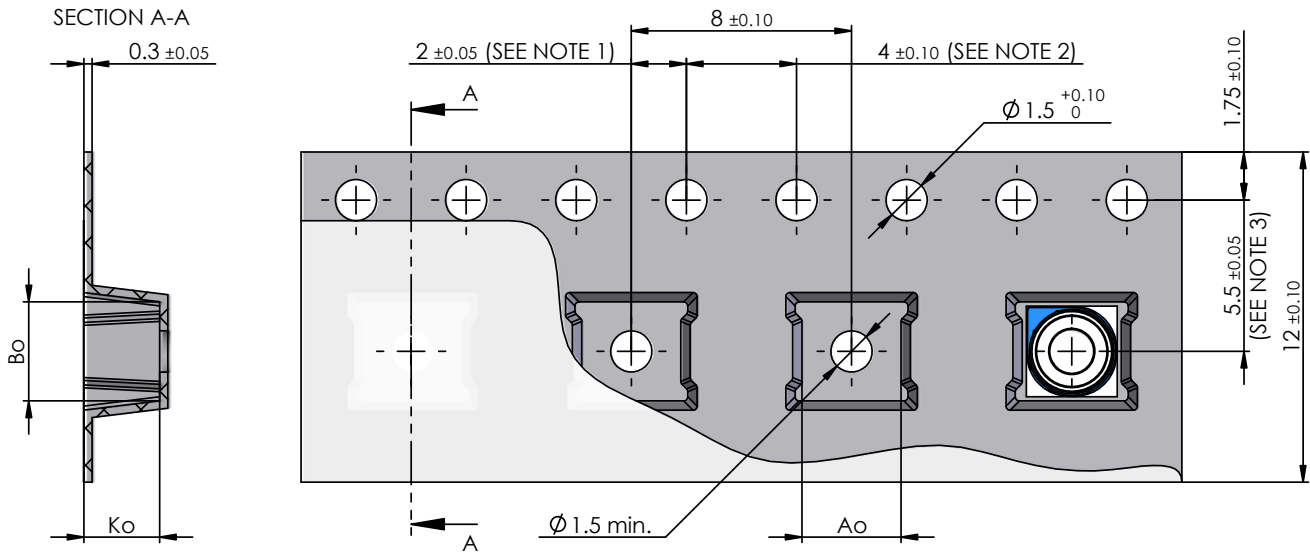

Ao	3.6±0.1
Bo	3.6±0.1
Ko	2.75±0.1

#### MODULE ORIENTATION

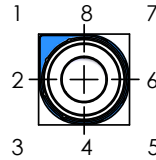

#### NOTE:

- 1: Measured from centerline of sprocket hole to centerline of pocket
- 2: Cumulative tolerance of 10 sprocket holes is  $\pm 0.2\text{mm}$
- 3: Measured from centerline of sprocket hole to centerline of pocket

## MS5849-30BA

Ultra-compact, chlorine resistant, absolute pressure sensor

### REEL INFORMATION

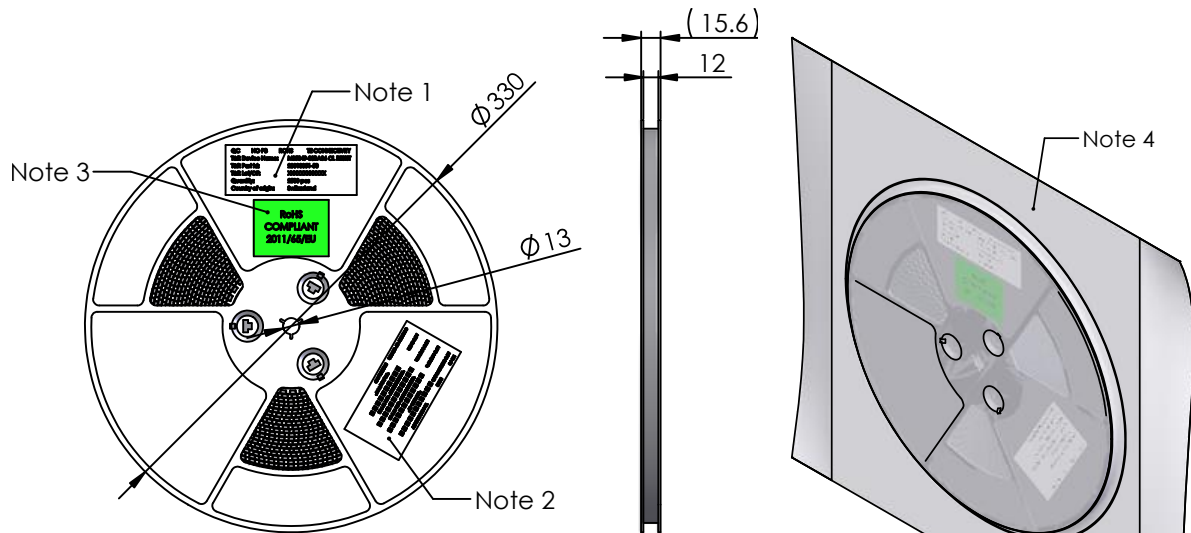

1. Fabrication order label of T&R
2. Fabrication order label of pressure sensors
3. RoHS compliance
4. Shipment inside an ESD vacuum bag
5. Total quantity: 2500 pcs

#### Information of the fabrication order label of T&R:

- No Pb indication
- RoHS indication
- Quality check indication
- Company logo (TE connectivity)
- Product name (stated as T&R device name)
- PN (stated as T&R Part id)
- T&R lot number
- Quantity (2500 pcs per reel)
- Country of origin

#### Information of the fabrication order label of pressure sensors:

- No Pb indication
- RoHS indication
- Company name (TE connectivity)
- Internal PN (stated as Manufacturing Device Name) – Bar code and written
- Manufacturing lot 1 – Bar code and written
- Manufacturing lot 2, if any – Bar code and written
- Manufacturing date – Bar code and written
- Country of origin

#### Information of the packaging box for one reel:

- Weight per unit: 0.1 g.
- Weight per T&R: 1 Kg.
- Material: Cardboard
- Box dimensions: 37 x 37 x 2 cm.
- License tag (LT)

## MS5849-30BA

Ultra-compact, chlorine resistant, absolute pressure sensor

## MOUNTING AND ASSEMBLY CONSIDERATIONS

### SOLDERING

Please refer to JEDEC standard IPC/JEDEC J-STD-033D and J-STD-020E soldering recommendations.

### MOUNTING

The MS5849 can be placed with an automatic pick & place equipment using vacuum nozzles. It will not be damaged by the vacuum. Because of the low stress assembly, the sensor does not show pressure hysteresis effects.

The gel inside the metal lid must not be touched or damaged during mounting or handling.

### CONNECTION TO PCB

The package outline of the pressure sensor allows the use of a flexible PCB. This is ideal for small-sized applications.

### SEALING WITH O-RING

In applications such as outdoor watches the electronics must be protected against direct water or humidity. For such applications the MS5849-30BA provides the possibility to seal with an O-ring. The O-ring shall be placed at the groove location, i.e. the small outer diameter of the metal lid. The following O-ring / housing dimensions are recommended:

- O-Ring hardness (Shore A) used in the evaluation assembly.  
Nitrile rubber (NBR) 70 Shore A.
- O-Ring sizes and tolerances used in the evaluation assembly.  
ID:  $1.8\text{mm} \pm 0.05$ ; Cord:  $0.8\text{mm} \pm 0.03$ .  
Watch industry O-Ring standard: NIHS62-02.
- O-Ring mount grease used in the evaluation assembly.  
NLGI Grade 2, PFPE grease.



O-Ring receptacle cylinder sizes and tolerances used in the evaluation assembly.

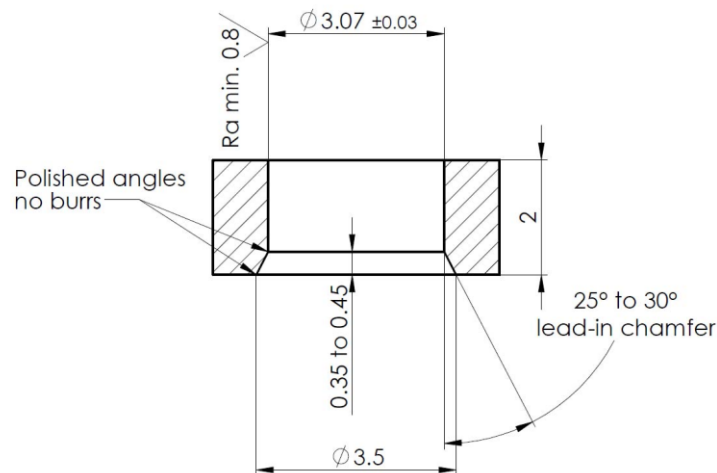



## MS5849-30BA

Ultra-compact, chlorine resistant, absolute pressure sensor

It is highly recommended to avoid rigid assembly from PCB board to sealing housing. The coupling between the pressure sensor and the sealing housing must allow flexibility to compensated for axial misalignment (see pictures below); otherwise, the stress created by the misalignment can shear the lid attach.

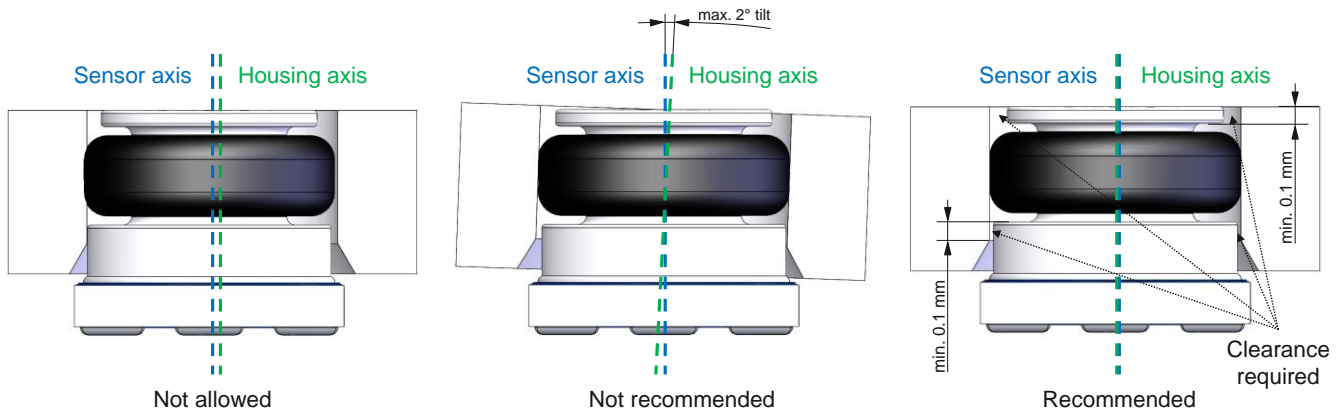

### CLEANING

The MS5849 has been manufactured under clean-room conditions. It is therefore recommended to assemble the sensor under class 10'000 or better conditions. Should this not be possible, it is recommended to protect the sensor opening during assembly from entering particles and dust. To avoid cleaning of the PCB, solder paste of type “no-clean” shall be used.

Warning: cleaning might damage the sensor.

### ESD PRECAUTIONS

The electrical contact pads are protected against ESD up to 8 kV HBM (human body model). It is therefore essential to ground machines and personal properly during assembly and handling of the device. The MS5849 is shipped in antistatic transport boxes. Any test adapters or production transport boxes used during the assembly of the sensor shall be of an equivalent antistatic material.

### DECOUPLING CAPACITOR

Particular care must be taken when connecting the device to the power supply. A minimum of 100nF ceramic capacitor must be placed as close as possible to the MS5849 VDD pin. This capacitor will stabilize the power supply during data conversion and thus, provide the highest possible accuracy.

## MS5849-30BA

Ultra-compact, chlorine resistant, absolute pressure sensor

### ORDERING INFORMATION

PART NUMBER	DESCRIPTION	SHIELDING	CHLORINE RESISTANT
20018051-50	MS5849-30BA36 CL RESISTANT LS	X	X



**your distributor**  
AMSYS GmbH & Co.KG  
An der Fahrt 4, 55124 Mainz, Germany  
Tel. +49 (0) 6131 469 875 0  
info@amsys.de | www.amsys.de

#### [te.com/sensorsolutions](https://te.com/sensorsolutions)

Measurement Specialties (MEAS), TE Connectivity, TE Connectivity (logo) and EVERY CONNECTION COUNTS are trademarks. All other logos, products and/or company names referred to herein might be trademarks of their respective owners.

The information given herein, including drawings, illustrations and schematics which are intended for illustration purposes only, is believed to be reliable. However, TE Connectivity makes no warranties as to its accuracy or completeness and disclaims any liability in connection with its use. TE Connectivity's obligations shall only be as set forth in TE Connectivity's Standard Terms and Conditions of Sale for this product and in no case will TE Connectivity be liable for any incidental, indirect or consequential damages arising out of the sale, resale, use or misuse of the product. Users of TE Connectivity products should make their own evaluation to determine the suitability of each such product for the specific application.

© 2019 TE Connectivity Ltd. family of companies All Rights Reserved.